

NEW EDITION

Extraction Sets
Extracting Forceps
Root Elevators
Bone Rongeurs
Orthodontic Pliers
Scalers
Impression Trays

DENTAL

INSTRUMENTS

High Quality Instruments



ELITE INTERNATIONAL

Manufacturer & Exporter

Block 2, Plot 2, S.I.E Sialkot - Pakistan
Phone: +92 52 3250269 / whatsapp: +92 321 6163600
Email: eliteinterpk@gmail.com
Web: www.eliteintl.pk / www.elitestore36.com

www.eliteintl.pk

Dear Valued Buyers

We feel immense pleasure to present our latest catalogue in which we have featured a most comprehensive range of all types of quality Surgical & Dental instruments required for day to day use for Hospital. We will be pleased to quote you a competitive Price and Delivery time.

All instruments are manufactured according to the recognized standard patterns currently in use in Hospital throughout the world and are being produced under restrict control of experts to avoid any flaw and to refrain any complaint at any stage.

A group of very vast experienced persons in manufacturing handling our quality Control System.

Any instruments proven defective in workmanship or material will be replaced with out charges.

We express our thanks to all our customers for the confidence they have placed us in the past. We further assure them that we will continue our best efforts to gain their confidence in the future.

We are always at your service.

01

EXTRACTING FORCEPS

Page # 01 - 28

02

ROOT ELEVATORS

Page # 29 - 48

03

**DIAGNOSTIC, PROBES, SCALERS, FILLING
& LABORATORY INSTRUMENTS**

Page # 49 - 98

04

**MAXILLOFACIAL SURGERY
INSTRUMENTS**

Page # 99 - 124

05

**ORTHODONTIC INSTRUMENTS
& PLIERS**

Page # 125 - 144

06

**DENTAL IMPLANT INSTRUMENTS
& Impression Tray**

Page # 145 - 182

07

HOLLOWWARE

Page # 183 - 191

Handle Selection For Extracting Forceps

Dear Valued Buyers if any Universal Fig. No. of Extracting Forceps not Found in our Catalogue you Can Refer the Fig. No. From These Diagram.

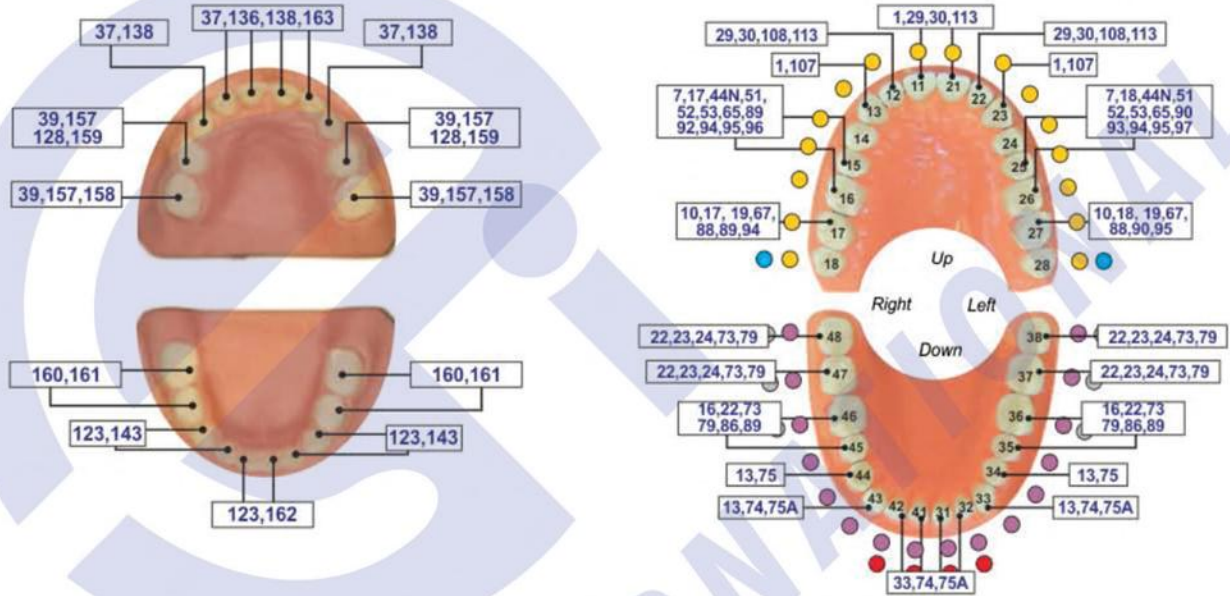

Dear Valued Buyers these are our Handle Styles



English Pattern



English Pattern



English Pattern, Anatomical Handle



American Pattern



Deep Grip Forceps With Hole Pattern



Hole Pattern



EXTRACTING FORCEPS (English Pattern)

- Щипцы экстракционные (английская форма)
- Daviers (Forme Anglaise)
- Zahnzangen (Englische Form)
- Щипці екстракційні (англійська форма)
- Forceps de Extracción (Forme Inglesa)
- استخراج المنقط (نمط اللغة الإنجليزية)

Function: To remove teeth from bony socket



EI-3600
Fig. 1
Upper Centrals
and Canines



EI-3601
Fig. 2
Upper Laterals
and Canines



EI-3602
Fig. 4
Lower Incisors
and Canines



EI-3603
Fig. 7
Upper Premolars



EI-3604
Fig. 8
Lower Premolars



EI-3605
Fig. 13
Lower Premolars



EI-3606
Fig. 17
Upper Molars,
Right



EI-3607
Fig. 18
Upper Molars, Left



EI-3608
Fig. 21
Lower Molar



EI-3609
Fig. 22
Lower Molar



Straight extracting forceps for upper incisors and canines



Straight extracting forceps for upper incisors and canines



Straight extracting forceps for upper incisors and canines

EXTRACTING FORCEPS (English Pattern)

- Щипцы экстракционные (английская форма)
- Давиеры (Forme Anglaise)
- Zahnzangen (Englische Form)
- Щипці екстракційні (англійська форма)
- Forceps de Extracción (Forme Inglesa)
- استخراج الملقط (نمط اللغة الإنجليزية)

Function: To remove teeth from bony socket



EI-3610
18A
upper molars

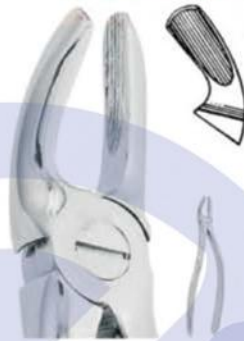

EI-3611
19
upper third molars



EI-3612
20
lower third molar



EI-3613
24
lower molar, right



EI-3614
29
upper roots



EI-3615
30
Upper Roots



EI-3616
33
lower roots



EI-3617
33A
Lower Roots



EI-3618
33M
Lower roots
with long beak



EI-3619
46L



EI-3620
51
Upper Roots



EI-3621
51A
Upper Roots



Straight extracting forceps for upper incisors and canines



Straight extracting forceps for upper incisors and canines



Straight extracting forceps for upper incisors and canines

EXTRACTING FORCEPS (English Pattern)

- Щипцы экстракционные (английская форма)
- Щипці екстракційні (англійська форма)
- Forceps de Extracción (Forme Inglesa)
- Zahnzangen (Englische Form)
- استخراج المنقط (تمط اللغة الإنجليزية)

Function: To remove teeth from bony socket

WISDOM EXTRACTING FORCEPS



EI-3622
Routerier
(# 22 ½ L)
lower molars and
wisdoms, left

EI-3623
Routerier
(# 22 ½ R)
lower molars and
wisdoms, right

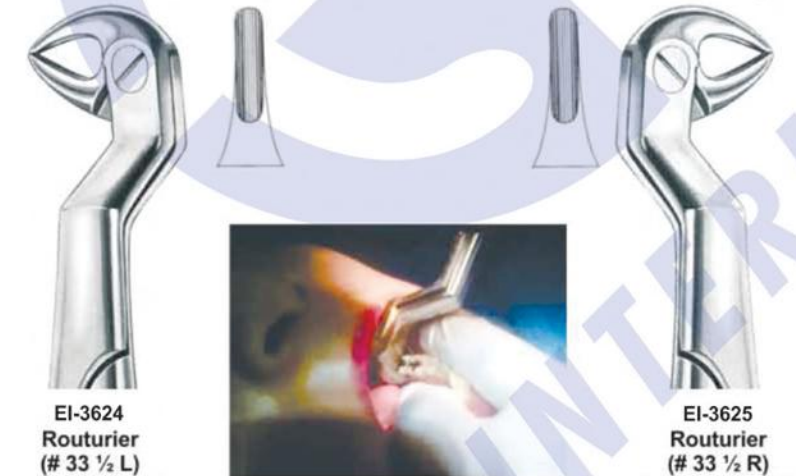

EI-3624
Routerier
(# 33 ½ L)
lower molar and
wisdom roots, left

EI-3625
Routerier
(# 33 ½ R)
lower molar and
wisdom roots, right

Routerier extracting forceps for lower molars and third molars, right



EI-3626
Fig. 186L
lower molars

EI-3627
Fig. 186R
lower molars



EI-3628
51AL



EI-3629
67
Upper Thrid Molars



EI-3630
67A
Upper Thrid Molars



EI-3631
79
Lower Thrid Molars



Angled extracting forceps for upper roots

EXTRACTING FORCEPS (English Pattern)

- Щипцы экстракционные (английская форма)
- Шпінці екстракційні (англійська форма)
- Forceps de Extracción (Forme Inglesa)
- استخراج الملقط (نمط اللغة الإنجليزية)
- Daviers (Forme Anglaise)
- Forceps de Extracción (Forme Inglesa)
- Zahnzangen (Englische Form)

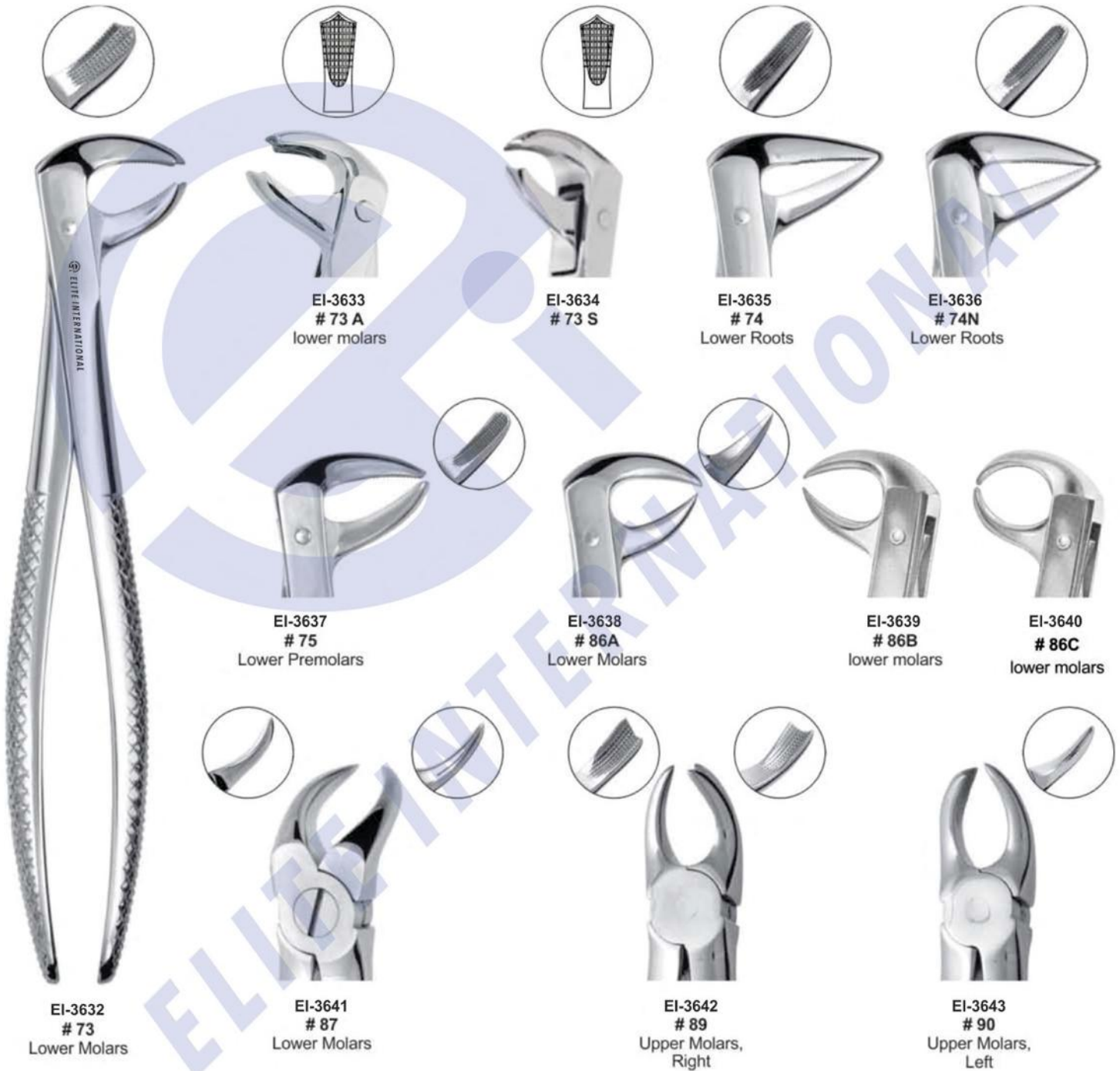

Straight extracting forceps for upper incisors and canines



Straight extracting forceps for upper incisors and canines



Straight extracting forceps for upper incisors and canines

EXTRACTING FORCEPS (English Pattern)

- Щипцы экстракционные (английская форма)
- Daviers (Forme Anglaise)
- Zahnzangen (Englische Form)
- Щипці екстракційні (англійська форма)
- Forceps de Extracción (Forme Inglesa)
- استخراج المنقط (تمط اللغة الإنجليزية)

DE-TRAUMATIC EXTRACTION

Improved tapered beaks for complete root contact. Cross serrations. Deep Gripe Extracting Forceps

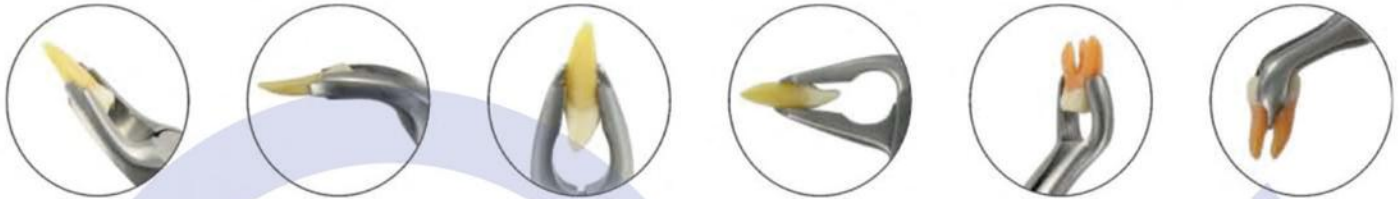

- No Fracture
- No Tissue Damage
- Extraction With Easy

Thin Tip



EI-3644
34

Upper incisors and premolars deep-gripping

Wide Tip



EI-3645
34A

Upper centrals / cains deep-gripping

Thin Tip



EI-3646
Fig. 35

upper permolars deep-gripping

Wide Tip



EI-3647
35A

Upper incisors and premolars deep-gripping

Thin Tip



EI-3648
36

Lower premolars deep-gripping

Wide Tip



EI-3649
36A

Lower premolars deep-gripping



EI-3650
336

lower permolars deep-gripping



EI-3651
F-7C

lower molar



EI-3652
9

Apex Forceps Lower Universal Deep Root Pick



EI-3653
79N

Lower third molars deep-gripping



EI-3654
79

Lower Thrid Molars



Function:

Extraction forceps are used to further loosen teeth by rotational and tilting movements and finally to extract the teeth in combination with a fulcrum.

EXTRACTING FORCEPS (English Pattern)

- Щипцы экстракционные (английская форма)
- Daviers (Forme Anglaise)
- Zahnzangen (Englische Form)
- Щипці екстракційні (англійська форма)
- Forceps de Extracción (Forme Inglesa)
- استخراج الملقط (نمط اللغة الإنجليزية)

DEEP ROOT PICK FORCEPS



EI-3655
146
Apex Forceps Lower Root
Deep Root Pick



EI-3656
153
Apex Forceps Upper Root
Deep Root Pick



EI-3657
149
Apex Forceps Upper Root
Deep Root Pick



EI-3658
Fig. 44



EI-3659
Fig. 44Z



EI-3660
Fig. 45Z



EI-3661
46XL
Apex Forceps Lower Root
Deep Root Pick



EI-3662
67
Upper Third Molars

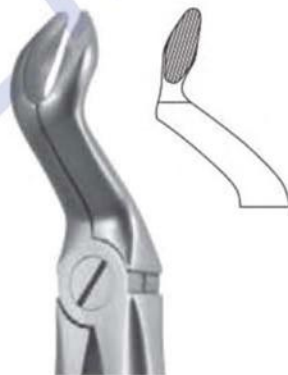

EI-3663
67A
Upper Third Molars



EI-3664
67N
Lower third molars
deep-gripping



EI-3665
331
upper roots
deep-gripping



forceps for upper incisors, premolars and roots



EXTRACTING FORCEPS (English Pattern)

- Щипцы экстракционные (английская форма)
- Щипці екстракційні (англійська форма)
- Forceps de Extracción (Forme Inglesa)
- استخراج المنقط (نمط اللغة الإنجليزية)
- Daviers (Forme Anglaise)
- Zahnzangen (Englische Form)



Fig. 1
upper
laterals
and canines



EI-3666
Set of 10 Pieces
Fig. 1
Fig. 7
Fig. 13
Fig. 17
Fig. 18
Fig. 22
Fig. 51A
Fig. 67
Fig. 74N
Fig. 79

Fig. 7
upper premolars



Fig. 13
lower premolars



Fig. 17
upper molars, right



Fig. 18
upper molars, left



Fig. 22
lower roots



Fig. 51A
upper roots



Fig. 67
upper third molars



Fig. 74N
lower molar



Fig. 79
lower third molars



Extracting forceps for upper roots



EXTRACTING FORCEPS

- Щипцы экстракционные
 - Daviers
 - Zahnzangen
- Щипці екстракційні
 - Forceps de Extracción
 - استخراج الملقط

Pediatric Tooth Extracting Forceps Set



EI-3667
English Pattern Klein #51S
Pedodontic Upper root



EI-3668
English Pattern Klein #137
Pedodontic, Upper Incisors Spring handle



EI-3669
English Pattern Klein #5
Pedodontic Lower Incisors.



EI-3670
English Pattern Klein #139
Pedodontic Upper Premolars

Baby Tooth Extraction Forceps



EI-3671
Fig. # 01 to 07
Set of 7 Pieces



EI-3672
English Pattern Klein #7
Pedodontic Lower Roots,



EI-3673
English Pattern Klein #3
Pedodontic Upper Molars Universal

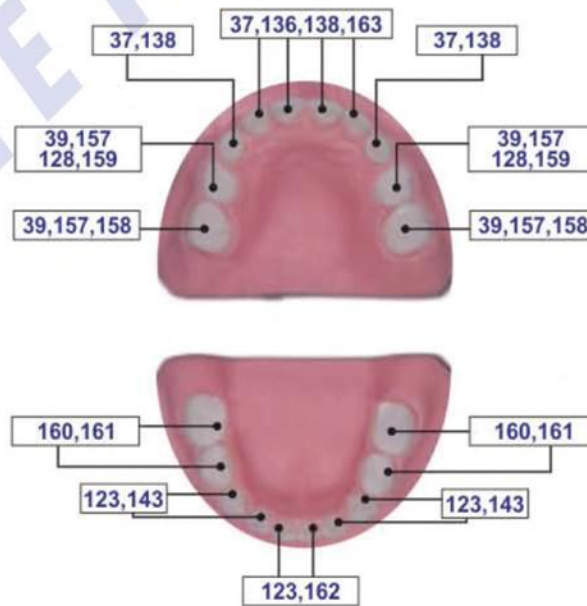

EI-3674
English Pattern Klein #6
Pedodontic Lower Molars, Spring Handle

ROOT FRAGMENT FORCEPS

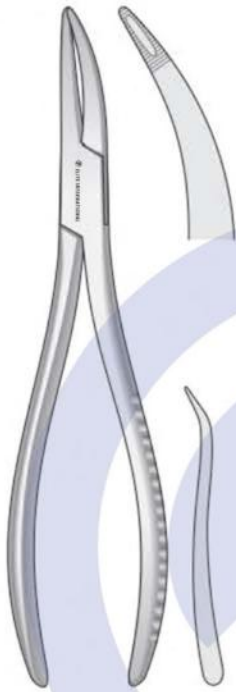

Witzel
EI-3675
170mm
Upper roots, Universal



Witzel
EI-3676
165mm
Lower roots, Universal



EI-3677
#400(300)
165mm
Upper roots, Universal



EI-3678
#401(301)
160mm
Lower roots, Universal



EI-3679
Witzel Forceps With Gold
Set of 3 Pcs



EI-3680
Witzel Forceps With Hole And Screw Pattern
Set of 3 Pcs



EI-3681
Witzel Forceps With Anatomical Handle
Set of 3 Pcs



EI-3682
#401(301)
160mm
Lower roots, Universal



EI-3683
#401(301)
160mm
Lower roots, Universal



EI-3684
#401(301)
160mm
Lower roots, Universal



EI-3685
#400(300)
165mm
Upper roots, Universal



EI-3686
#400(300)
165mm
Upper roots, Universal



EI-3687
#400(300)
165mm
Upper roots, Universal



Witzel
EI-3688
165mm
Lower roots, Universal



Witzel
EI-3689
165mm
Lower roots, Universal



Witzel
EI-3690
165mm
Lower roots, Universal

ROOTS SPLINTER FORCEPS

- Щипцы для удаления корневых осколков
- Pincers Fragments
- Wurzelsplitterzangen
- Щипці для видалення корневих осколків
- Pinzas Para Fragmentos
- جذور منشقة الملقط



EI-3691
Splinter Forceps
15.5cm



Stieglitz Root Splinter Forceps



EI-3692
Splinter Forceps
15.5cm 45°



EI-3693
Stieglitz
Root Fragments



EI-3694
Stieglitz
Root Fragments



EI-3695
Stieglitz Splinter Forceps
140mm 90°



EI-3696
Stieglitz Splinter Forceps
140mm Straight

ROOT FRAGMENT FORCEPS

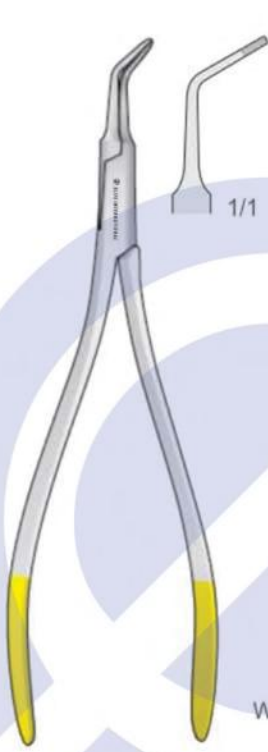

EI-3697
130mm

With Diamond



EI-3698
130mm

With Diamond

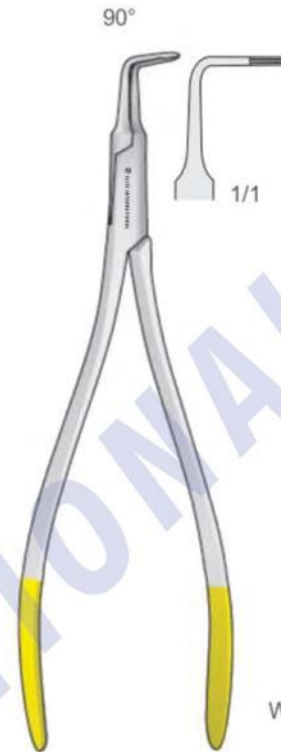

EI-3699
125mm

With Diamond



EI-3700
130mm



EI-3701
130mm



EI-3702
125mm

EXTRACTING FORCEPS (American Pattern)

- Щипцы экстракционные (американская форма)
- Daviers - forme américaine
- Fórceps de extracción - forma americana
- Щипці екстракційні (американська форма)
- Pinzoper per estrazione - forma americana
- استخراج المنقط (النمط الأمريكي)



EI-3703
1STD
Winter
upper centrals and canines

EI-3704
Fig. 1
upper incisors
and roots

EI-3705
Cryer
Fig. 150

EXTRACTING FORCEPS (American Pattern)

- Щипцы экстракционные (американская форма)
- Щипці екстракційні (американська форма)
- Daviers - forme américaine
- Pinzeper per estrazione - forma americana
- Fórceps de extracción - forma americana
- استخراج المنقط (النمط الأمريكي)



EI-3707
Fig. 62
incisors, premolars,
deciduous teeth



EI-3708
10S
upper roots



EI-3709
17
lower molars

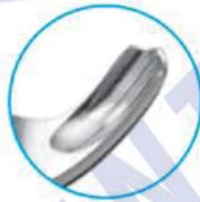

EI-3710
Harris
Fig. 18R



EI-3711
Harris
Fig. 18L

EI-3706
Fig. 150A
Cryer
upper incisors, premolars, roots

EXTRACTING FORCEPS (American Pattern)

- Щипцы экстракционные (американская форма)
- Щипці екстракційні (американська форма)
- Daviers - forme américaine
- Pinzere per estrazione - forma americana
- Férceps de extracción - forma americana
- استخراج الملقط (النمط الأمريكي)



EI-3712
Fig. 210
upper third molars



EI-3713
Fig. 53R
upper molars, right



EI-3714
Fig. 53L
upper molars, left



EI-3715
NEVIUS
Fig. 88R



EXTRACTING FORCEPS (American Pattern)

- Щипцы экстракционные (американская форма)
- Daviers - forme américaine
- Fórceps de extracción - forma americana
- Щипці екстракційні (американська форма)
- Pinzaper per estrazione - forma americana
- استخراج المنقط (النمط الأمريكي)



EI-3716
Fig. 24
upper molars



EI-3717
210S
upper third molars



EI-3718
210H
upper third molars



EI-3719
286
Upper Roots,
Premolars, Incisors



EI-3720
99C
Kells
upper incisors,
canines, premolars



EI-3721
222
lower third molars



EI-3722
286
Lower Molar

EXTRACTING FORCEPS (American Pattern)

- Щипцы экстракционные (американская форма)
- Щипці екстракційні (американська форма)
- Daviers - forme américaine
- Pinzere per estrazione - forma americana
- Fórceps de extracción - forma americana
- استخراج المنطق (النمط الأمريكي)



EI-3723
Nevius
Fig. 88L
upper molars, left

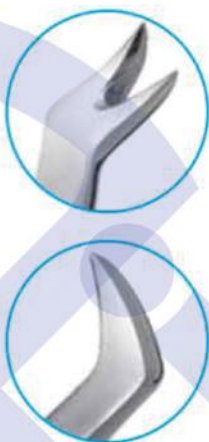

EI-3724
Fig. 65
upper incisors
and roots



EI-3725
Parmly Fig. 32A
upper premolars
and roots



EI-3726
Parmly Fig. 32
upper premolars
and molars

EXTRACTING FORCEPS (American Pattern)

- Щипцы экстракционные (американская форма)
- Щипці екстракційні (американська форма)
- Daviers - forme américaine
- Pinzere per estrazione - forma americana
- Fórceps de extracción - forma americana
- استخراج الملقط (النمط الأمريكي)

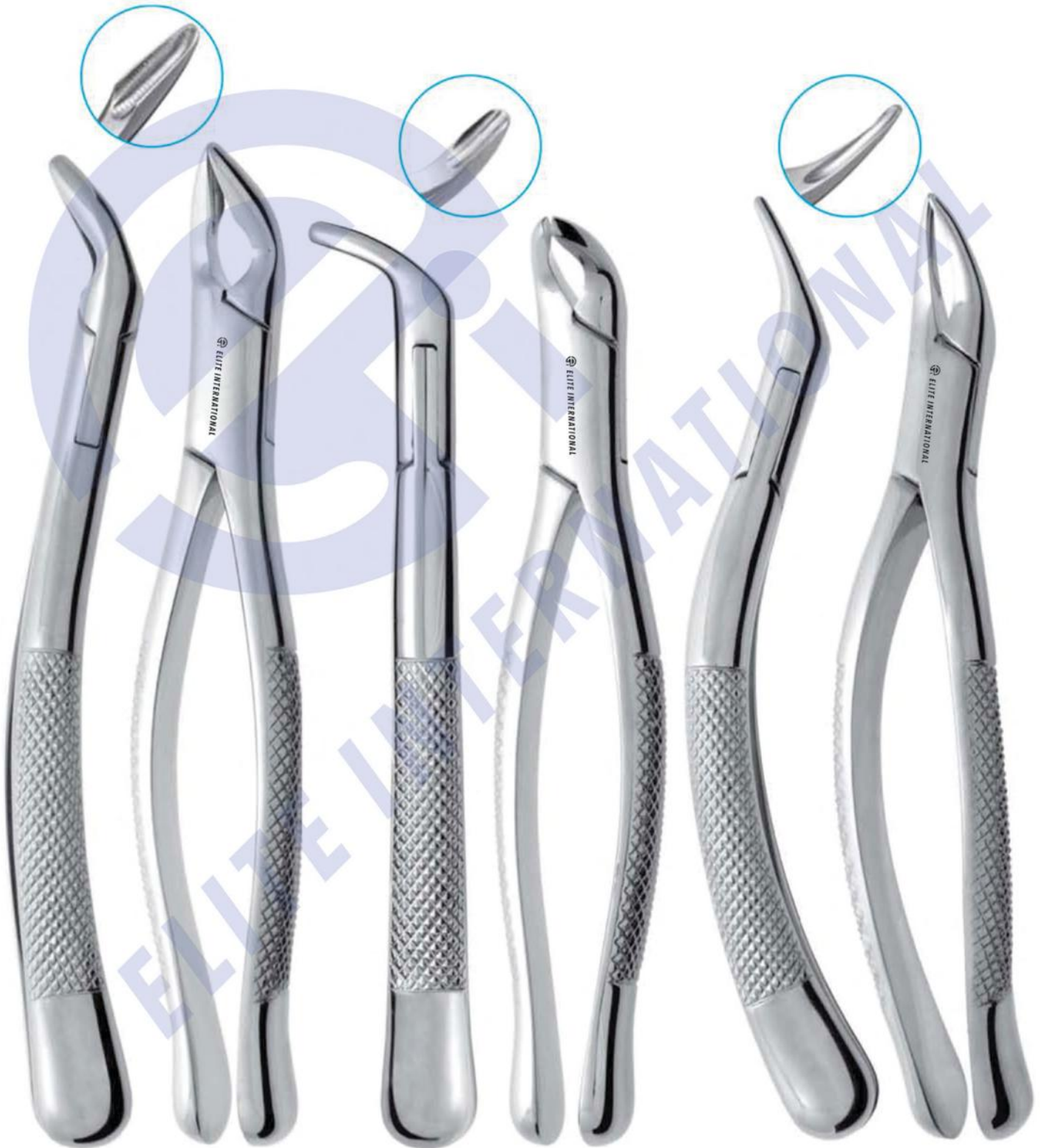

EI-3727
COHEN
universal

EI-3728
Fig. 203
lower incisors
and roots

EI-3729
Tomes Fig. 69
upper and lower
roots

EXTRACTING FORCEPS (American Pattern)

- Щипцы экстракционные (американская форма)
- Щипці екстракційні (американська форма)
- Daviers - forme américaine
- Pinzeta per estrazione - forma americana
- Férceps de extracción - forma americana
- استخراج المنقط (النمط الأمريكي)



EXTRACTING FORCEPS (American Pattern)

- Щипцы экстракционные (американская форма)
- Щипці екстракційні (американська форма)
- Daviers - forme américaine
- Pinzeper per estrazione - forma americana
- Fórceps de extracción - forma americana
- استخراج الملقط (النمط الأمريكي)



EI-3735
Hull
Fig. 101
Deciduous teeth

EI-3736
Cryer
Fig. 150S
upper teeth,
for children

EI-3737
Fig. 150 AS

EXTRACTING FORCEPS (American Pattern)

- Щипцы экстракционные (американская форма)
- Щипці екстракційні (американська форма)
- Daviers - forme américaine
- Pinzere per estrazione - forma americana
- Fórceps de extracción - forma americana
- استخراج المنطق (النمط الأمريكي)



EI-3738
Cryer
Fig. 151
lower teeth,
for children

EI-3739
Fig. 151 S
lower incisors,
premolars, roots

EI-3740
Fig. 151 AS

EXTRACTING FORCEPS (American Pattern)

- Щипцы экстракционные (американская форма)
- Daviers - forme américaine
- Fórceps de extracción - forma americana
- Щипці екстракційні (американська форма)
- Pinzaper per estrazione - forma americana
- استخراج المنقط (النمط الأمريكي)



EI-3741
16S
lower molars for children



EI-3742
17S
lower molars



EI-3743
23 S
Lower molars

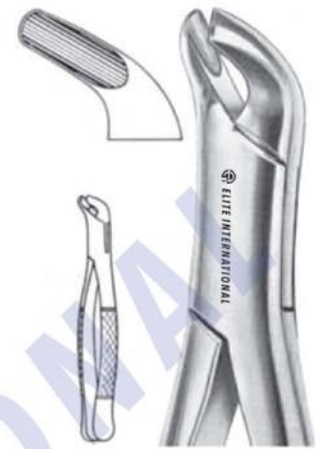

EI-3744
27
lower molars



EI-3745
18LS
upper molars left



EI-3746
18RS
upper molars right



EI-3747
85 Tomas
lower canines, premolars and molars



EI-3748
85A Tomas
lower canines, premolars and molars



EI-3749
69S
upper and lower roots



EI-3750
99A Kells
upper incisors, canines, premolars



EI-3751
217
lower molars

EXTRACTING FORCEPS (American Pattern)

- Щипцы экстракционные (американская форма)
- Давильи - forme americane
- Férceps de extracción - forma americana
- Щипці екстракційні (американська форма)
- Pinzere per estrazione - forma americana
- استخراج المنطق (النمط الأمريكي)



EI-3752
#10 SK
Upper Molars Sup



EI-3753
#17 SK Universal
Lower Molars



EI-3754
#23 SK Universal
Upper Molars



EI-3755
#69 SK Tomas
upper and lower roots



EI-3756
#99 SK
upper incisors,
canines, premolars



EI-3757
#150 SK
upper incisors,
premolars, roots



EI-3758
#151 SK
lower incisors,
premolars, roots



EI-3759
#222 SK
lower third molars

EXTRACTING FORCEPS (American Pattern)

- Щипцы экстракционные (американская форма)
- Daviers - forme américaine
- Fórceps de extracción - forma americana
- Щипці екстракційні (американська форма)
- Pinzaper per estrazione - forma americana
- استخراج المنقط (النمط الأمريكي)



EI-3760
Fig. 1
Upper Anterior

EI-3761
Lower Molar
Fig. 23 Cow Horn



EI-3762
Fig. 74
Lower Anterior



EI-3763
Fig. 88L
Upper Molar Left



EI-3764
Fig. 88R
Upper Molar Right



EI-3765
Fig. 74
Lower Anterior



EI-3766
Fig. 106
Lower Incisors



EI-3767
Fig. 174
Extra Narrow
Lower Anterior
Apical Retention
Forceps



EI-3768
Fig. 859
Lower Molars
Roots



EXTRACTING FORCEPS (American Pattern)

- Щипцы экстракционные (американская форма)
- Щипці екстракційні (американська форма)
- Daviers - forme américaine
- Pinzere per estrazione - forma americana
- Fórceps de extracción - forma americana
- استخراج الملقط (النمط الأمريكي)

Carbide Diamond Coated Point



EI-3769
150 T.C.
Carbide Serrated Beak
Upper Incisors, Cuspids,
Bicuspid & Roots,
Universal



EI-3770
151 T.C.
Carbide Serrated Beak
Lower Incisors, Cuspids,
Bicuspid & Roots, Universal



EI-3771
1STD T.C.
Carbide Serrated Beak
Upper Incisors, Cuspids,



EI-3772
17 T.C.
Carbide Serrated Beak
1st & 2nd Lower Molars,
Universal



EI-3773
53L T.C.
Carbide Serrated Beak
1st & 2nd Upper Molars,
Left



EI-3774
53R T.C.
Carbide Serrated Beak
1st & 2nd Upper Molars,
Right



EI-3775
65 T.C.
Carbide Serrated Beak
Upper Incisors, Roots &
Fragments



EI-3776
69 T.C.
Carbide Serrated Beak
Upper & Lower Fragments
And Roots



EI-3777
150S T.C. Pedro forcep
Carbide Serrated Beak
Pedo, Upper Primary Teeth
and Roots, Universal



EI-3778
151S T.C. Pedro forcep
Carbide Serrated Beak
Pedo, Lower Primary Teeth
and Roots, Universal

BONE ROUNGER

- Костные кусачки
- Hohlmeißelzangen
- Pincés-gouges
- Кусачки для кісток
- Pinzas-gubias
- روتجیورس العظام



EI-3779
Blumenthal
15cm



EI-3780
Blumenthal
15cm



EI-3781
Blumenthal
15cm



EI-3782
Friedman
14cm



EI-3783
Friedman
14.5cm



EI-3784
Micro-Friedman
14cm



EI-3785
Micro-Friedman
15cm



EI-3786
Micro-Friedman
16cm



EI-3787
Kleinert-Kutz
18.5cm



EI-3788
Beyer
18.5cm



EI-3789
Mead 1A
18.5cm



EI-3790
Luer
18.5cm

EXTRACTING FORCEPS (English Pattern)

- Щипцы экстракционные (английская форма)
- Daviers (Forme Anglaise)
- Zahnzangen (Englische Form)
- Щипці екстракційні (англійська форма)
- Forceps de Extracción (Forme Inglesa)
- استخراج الملقط (نمط اللغة الإنجليزية)



EI-3791
Meissner
Extracting Forceps

EI-3792
Meissner
Extracting Forceps

EI-3793
Meissner
Extracting Forceps

EI-3794
Comellas Forceps
Anatomical Handle

DENTAL SYRINGES

- Шприцы стоматологические карпульные
- Шприці стоматологічні карпульні
- Seringues à usage dentaire
- Jeringas dentales
- Dentalspritzen
- المحاقن الأسنان



EI-3795 1.8ml
EI-3796 2.2ml



EI-3801 1.8ml
EI-3802 2.2ml



EI-3807 1.8ml
EI-3808 2.2ml



EI-3813 1.8ml
EI-3814 2.2ml



EI-3819 1.8ml
EI-3820 2.2ml



EI-3825 1.8ml
EI-3826 2.2ml



EI-3831
1001
Intraligamental
Anesthesia
Syringe in
Black Colour



EI-3836 1.8ml
EI-3837 2.2ml
Angled



EI-3842
Aluminium - Dark 1.8 ml

- | | | | |
|---|---|---|---|
|  |  |  |  |
| DE-212
Aluminium -
Silver 1.8 ml | DE-213
Aluminium -
Orange 1.8 ml | DE-214
Aluminium -
Green 1.8 ml | DE-215
Aluminium -
Blue 1.8 ml |



Type C
EI-3797 1,8ml
EI-3798 2,2ml



Type C
EI-3803 1,8ml
EI-3804 2,2ml



2-Ring
EI-3809 1,8ml
EI-3810 2,2ml



Aspirating Syringe
EI-3815 1.8mm
EI-3816 2.2mm



Cartridge Syringe
EI-3821 1.8mm
EI-3822 2.2mm



Cartridge Syringe
EI-3827 1.8mm
EI-3828 2.2mm



Cartridge Syringe
EI-3832 1.8mm
EI-3833 2.2mm

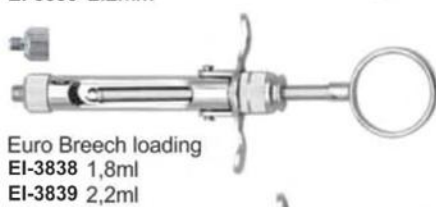

Euro Breech loading
EI-3838 1,8ml
EI-3839 2,2ml



EuroBreech loading
EI-3843 1,8ml
EI-3844 2,2ml



Manual Aspirating Syringe
EI-3799 1,8ml
EI-3800 2,2ml



Quatro
EI-3805 1,8ml
EI-3806 2,2ml



Trio
EI-3811 1,8ml
EI-3812 2,2ml



Swedish Type
EI-3817 1,8ml
EI-3818 2,2ml



Ject Ultima
EI-3823 1,8ml
EI-3824 2,2ml
Injects 0,05 ml with every click Supplied with
angled and straight tubes

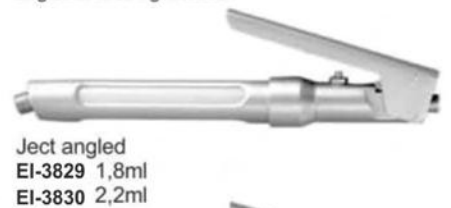

Ject angled
EI-3829 1,8ml
EI-3830 2,2ml



Ject straight
EI-3834 1,8ml
EI-3835 2,2ml



Disc System
EI-3840 1,8ml
EI-3841 2,2ml



Disc System
EI-3845 1,8ml

EXTRACTING FORCEPS SET

Извлечение щипцов
Ensemble de pinces d'extraction
• Zange sammeln

• Витягуючий комплект щипців
• Extracción del conjunto de fórceps
• استخراج ملقط مجموعة



EI-3846
Extracting Forceps
Set of 10 Pieces
Extracting Forceps Fig. 2
Extracting Forceps Fig. 7
Extracting Forceps Fig. 13
Extracting Forceps Fig. 17
Extracting Forceps Fig. 18
Extracting Forceps Fig. 22
Extracting Forceps Fig. 33
Extracting Forceps Fig. 51A
Extracting Forceps Fig. 67A
Extracting Forceps Fig. 79



EI-3847
Extracting Forceps
Set of 10 Pieces
Extracting Forceps Fig. 2
Extracting Forceps Fig. 7
Extracting Forceps Fig. 13
Extracting Forceps Fig. 17
Extracting Forceps Fig. 18
Extracting Forceps Fig. 22
Extracting Forceps Fig. 33
Extracting Forceps Fig. 51A
Extracting Forceps Fig. 67A
Extracting Forceps Fig. 79



EI-3848
Extracting Forceps
Set of 13 Pieces
Extracting Forceps Fig. 2
Extracting Forceps Fig. 7
Extracting Forceps Fig. 13
Extracting Forceps Fig. 17
Extracting Forceps Fig. 18
Extracting Forceps Fig. 22
Extracting Forceps Fig. 33
Extracting Forceps Fig. 51A
Extracting Forceps Fig. 67A
Extracting Forceps Fig. 79
Extracting Forceps Fig. 86C
Extracting Forceps Fig. 89
Extracting Forceps Fig. 90



EI-3849
Extracting Forceps Children Pattern
Set of 10 Pieces
Extracting Forceps Fig. 13S
Extracting Forceps Fig. 22S
Extracting Forceps Fig. 30S
Extracting Forceps Fig. 33S
Extracting Forceps Fig. 37
Extracting Forceps Fig. 38
Extracting Forceps Fig. 39
Extracting Forceps Fig. 39L
Extracting Forceps Fig. 39R
Extracting Forceps Fig. 51S



EI-3850
Extracting Forceps English adult Adult
Set of 10 Pcs



EI-3851
Extracting Forceps American Adult
Set of 10 Pcs



EI-3852
Extracting Forceps American Adult
Set of 8 Pcs



EI-3853
Extracting Forceps Pedro
Set of 7 Pcs

ROOT ELEVATOR

FUNCTION OF ROOT ELEVATORS IN SURGERY

To Loosen Tooth or Root From Bony Socket Prior to Placement of The Extraction Forceps.

HANDLES FOR ROOT ELEVATORS POINTS A, B, C, D, E, F, G, H

Thumb Handle



Shortblast Handle



Half Gold Handle



Round With Edge Handle



Thom with Flat Handle



Finger Thom Handle



Anatomical Handle



Eye Style Handle



ROOT ELEVATOR

- Элеватор корневой экстракционный
- Elévateurs à racines
- Wurzelheber
- Elevator corneviu extracționiu
- Elevadores para raices
- المصاعد الجذر

Function of Root Elevators:

To loosen tooth or root from bony socket prior to placement of the extraction forceps.

Apexo Root Elevators



Luxator Root Elevators



Bein Root Elevators

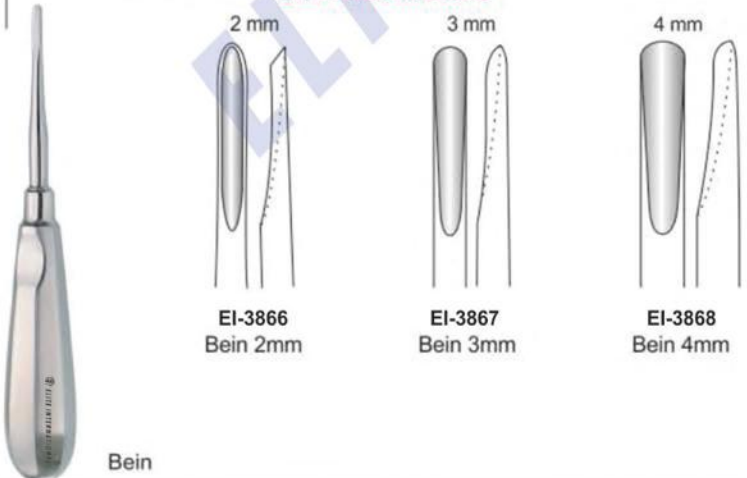

Seldin Root Elevators

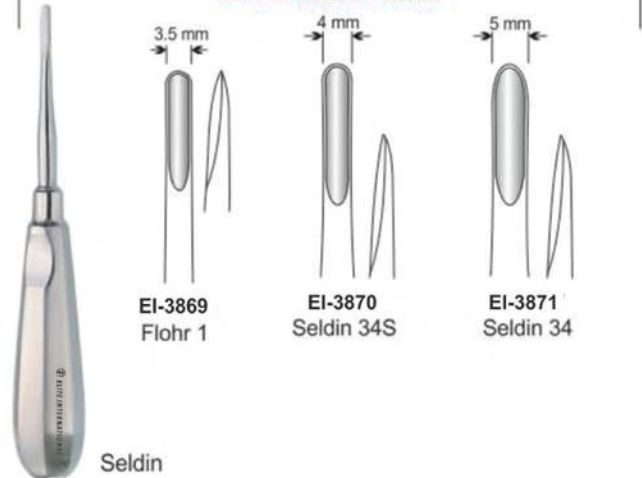

ROOT ELEVATOR

- Элеватор корневой экстракционный
- Elévateurs à racines
- Wurzelheber
- Слеватор корневий экстракційний
- Elevadores para raices
- المصاعد الجذر

FUNCTION: To loosen tooth or root from bony socket prior to placement of the extraction forceps.

Laxutor Root Elevators

Long Type



Laxutor Root Elevator



EI-3872
Laxutor
1.5mm
Str.



EI-3873
Laxutor
2mm
Str.



EI-3874
Laxutor
3mm
Str.



EI-3875
Laxutor
5mm
Str.



EI-3876
Laxutor
3mm
Cvd.



EI-3877
Laxutor
5mm
Cvd.



EI-3878
Laxutor
3mm
Upper Angle



EI-3879
Laxutor
3mm
Double Angle



EI-3880
Laxutor
3mm
Str.



EI-3881
Laxutor
5mm
Str.



ROOT ELEVATOR

- Элеватор корневой экстракционный
- Elévateurs à racines
- Wurzelheber
- Слеватор корневий экстракційний
- Elevadores para raices
- المصاعد الجذر

Laxutor Root Elevators

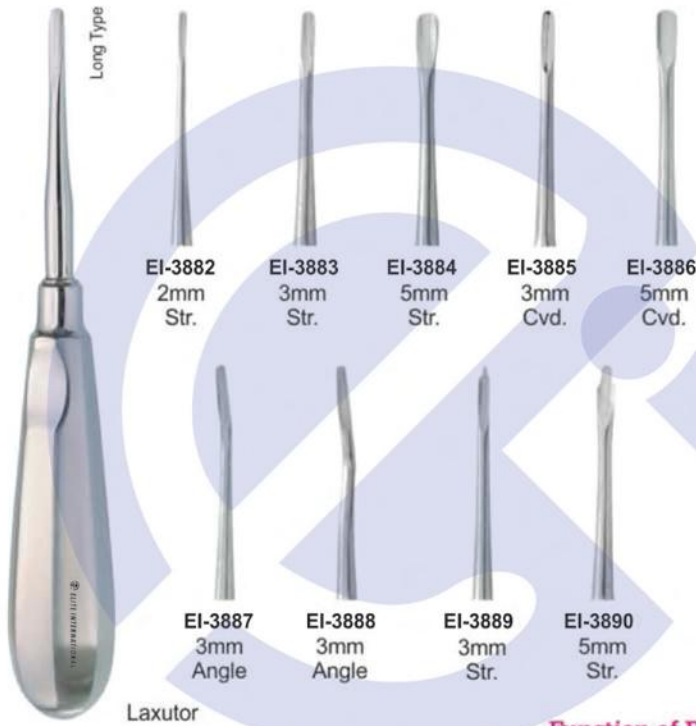

lower roots elevator



Upper root elevator with helicoidal tip

Luxator Roots Elevator



Function of Root Elevators:

To loosen tooth or root from bony socket prior to placement of the extraction forceps.

Apical Root Elevators

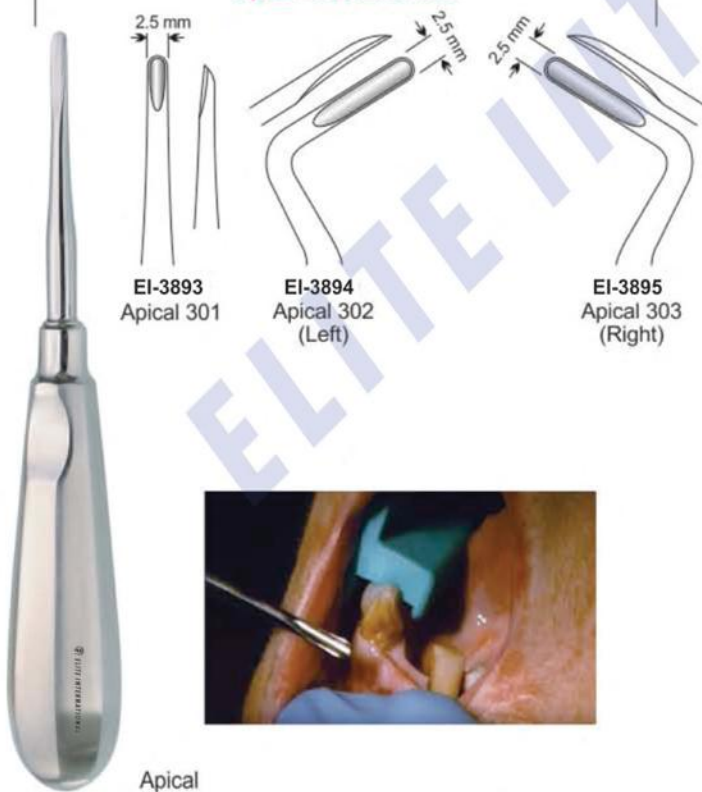

Apical Root Elevators

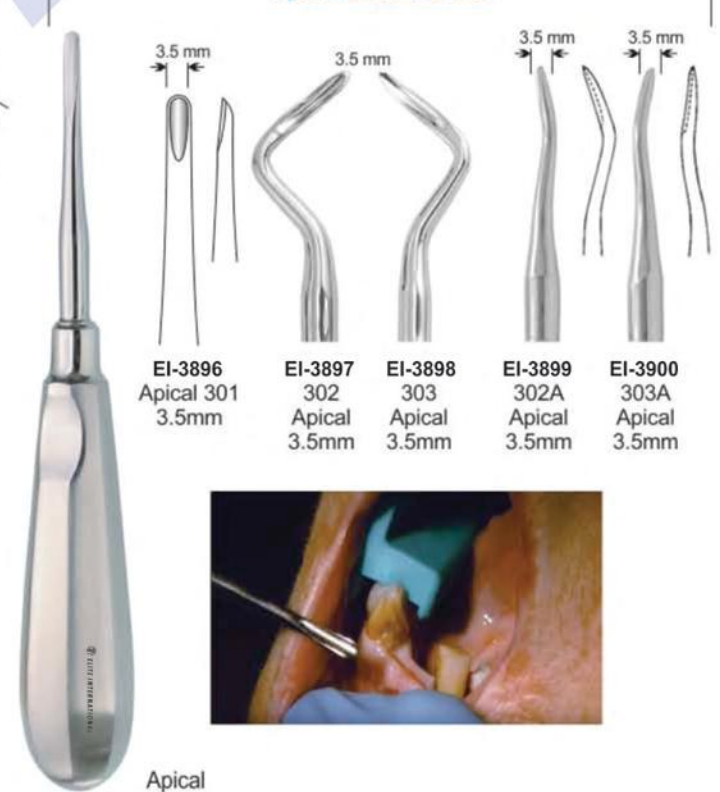

ROOT ELEVATOR

- Элеватор корневой экстракционный
- Elévateurs à racines
- Wurzelheber
- Слеватор корневий екстракційний
- Elevadores para raices
- المصاعد الجذر

FUNCTION: To Loosen Tooth or Root From Bony Socket Prior to Placement of The Extraction Forceps.

Cryer Root Elevators

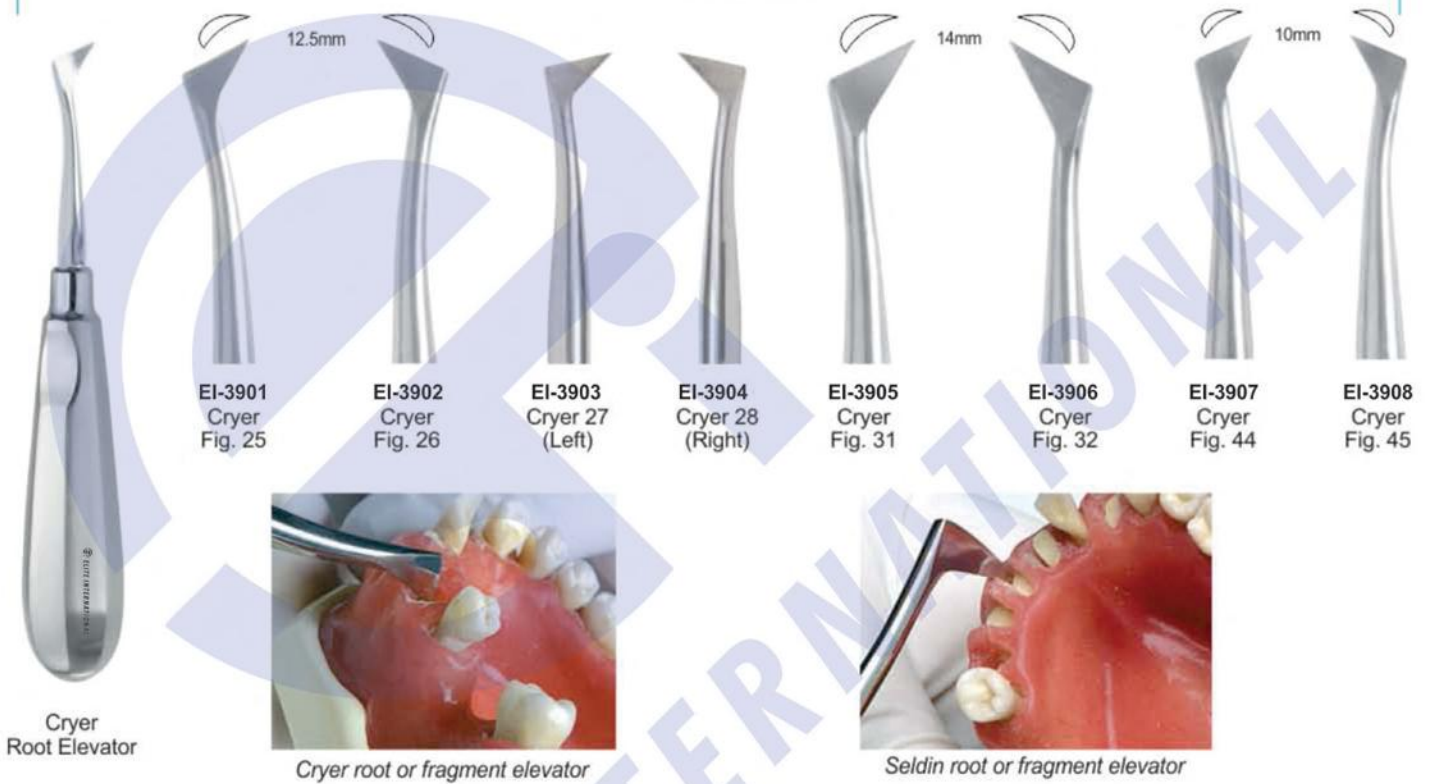

Seldin Root Elevators

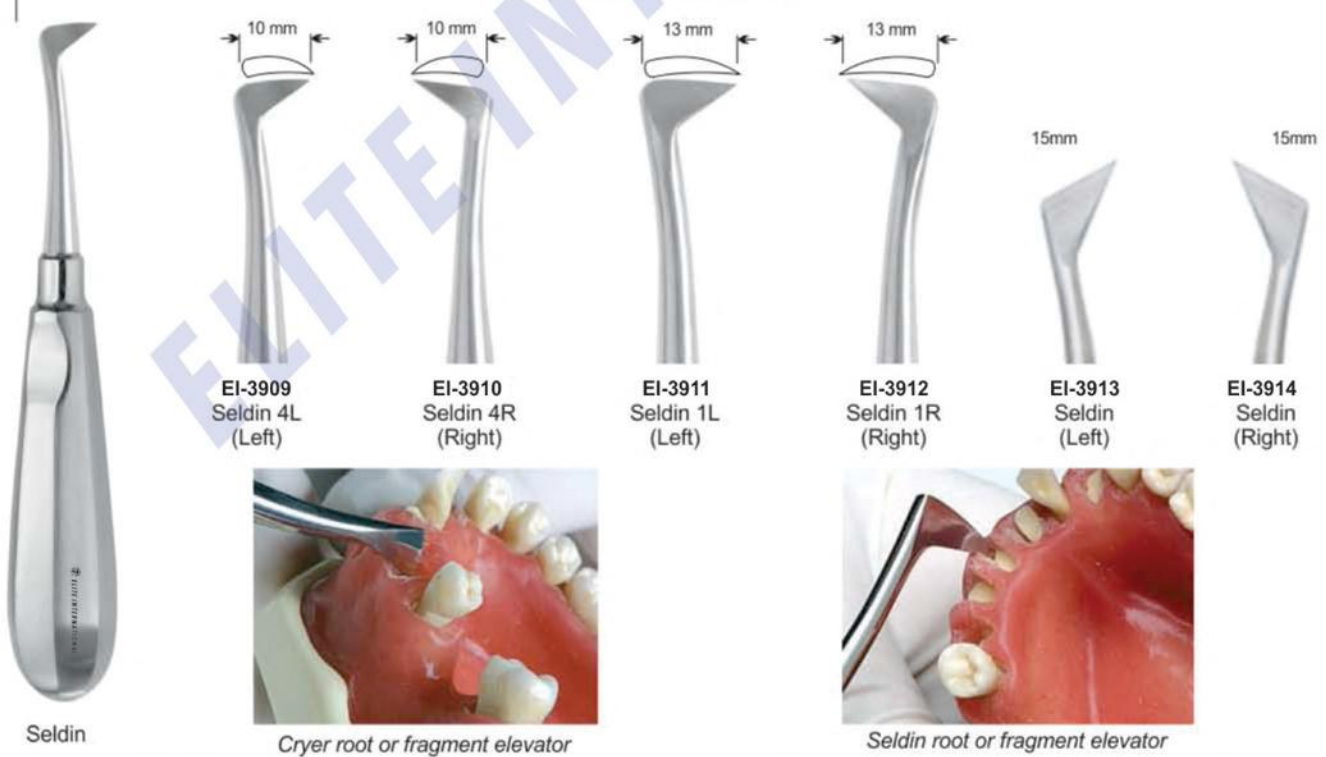

ROOT ELEVATOR

- Элеватор корневой экстракционный
- Elévateurs à racines
- Wurzelheber
- Слеватор корневий экстракційний
- Elevadores para raices
- المصاعد الجذر

FUNCTION: To Loosen Tooth or Root From Bony Socket Prior to Placement of The Extraction Forceps.

Apical Root Elevators

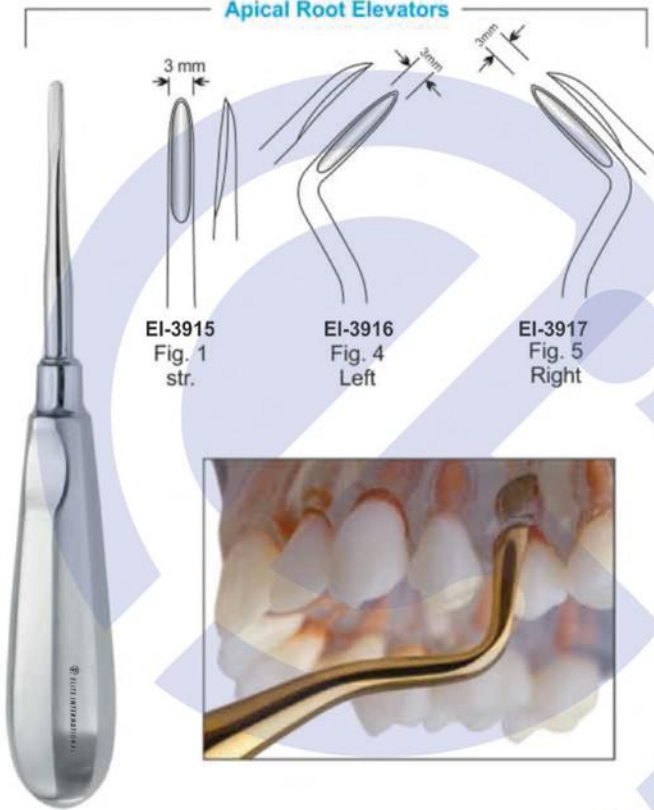

Apical Root Elevators

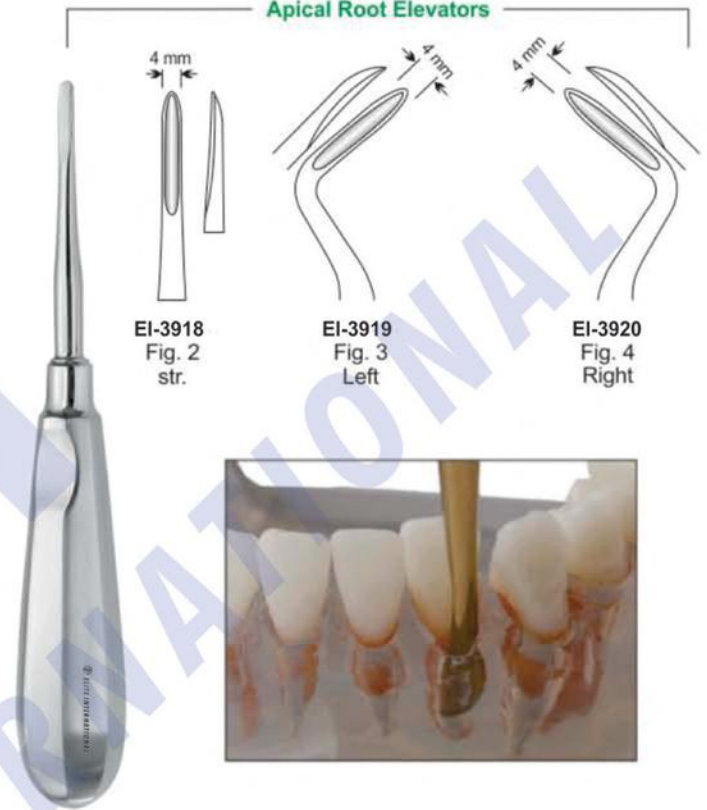

Flohr Root Elevators



Heidbrink Root Elevators

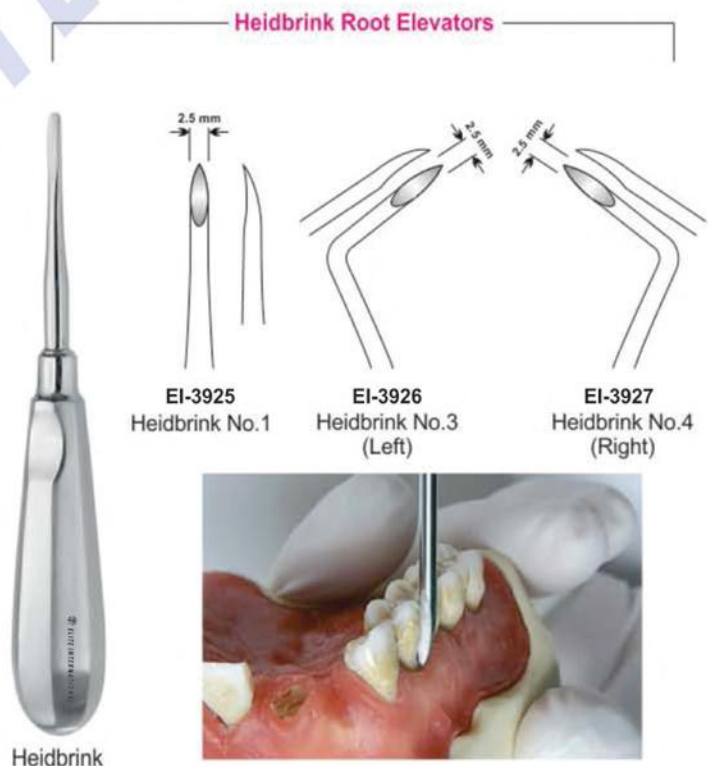

ROOT ELEVATOR

- Элеватор корневой экстракционный
- Elévateurs à racines
- Wurzelheber
- Слеватор корневий экстракційний
- Elevadores para raices
- المصاعد الجذر

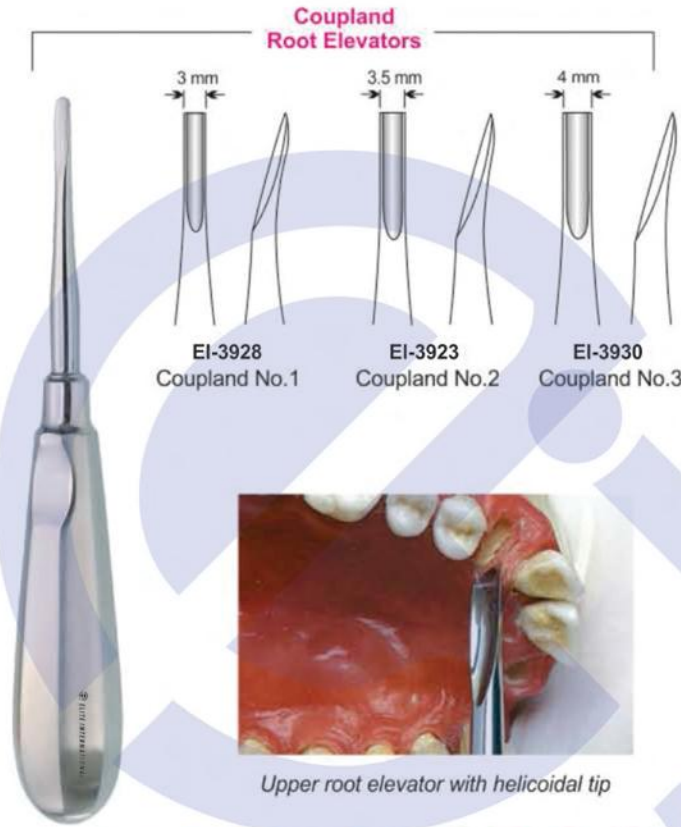

FUNCTION: To Loosen Tooth or Root From Bony Socket Prior to Placement of The Extraction Forceps.

ENGLISH PATTERNS



ROOT ELEVATOR

- Элеватор корневой экстракционный
- Elévateurs à racines
- Wurzelheber
- Слеватор корневий екстракційний
- Elevadores para raices
- المصاعد الجذر

Lindo Levian Root Elevators

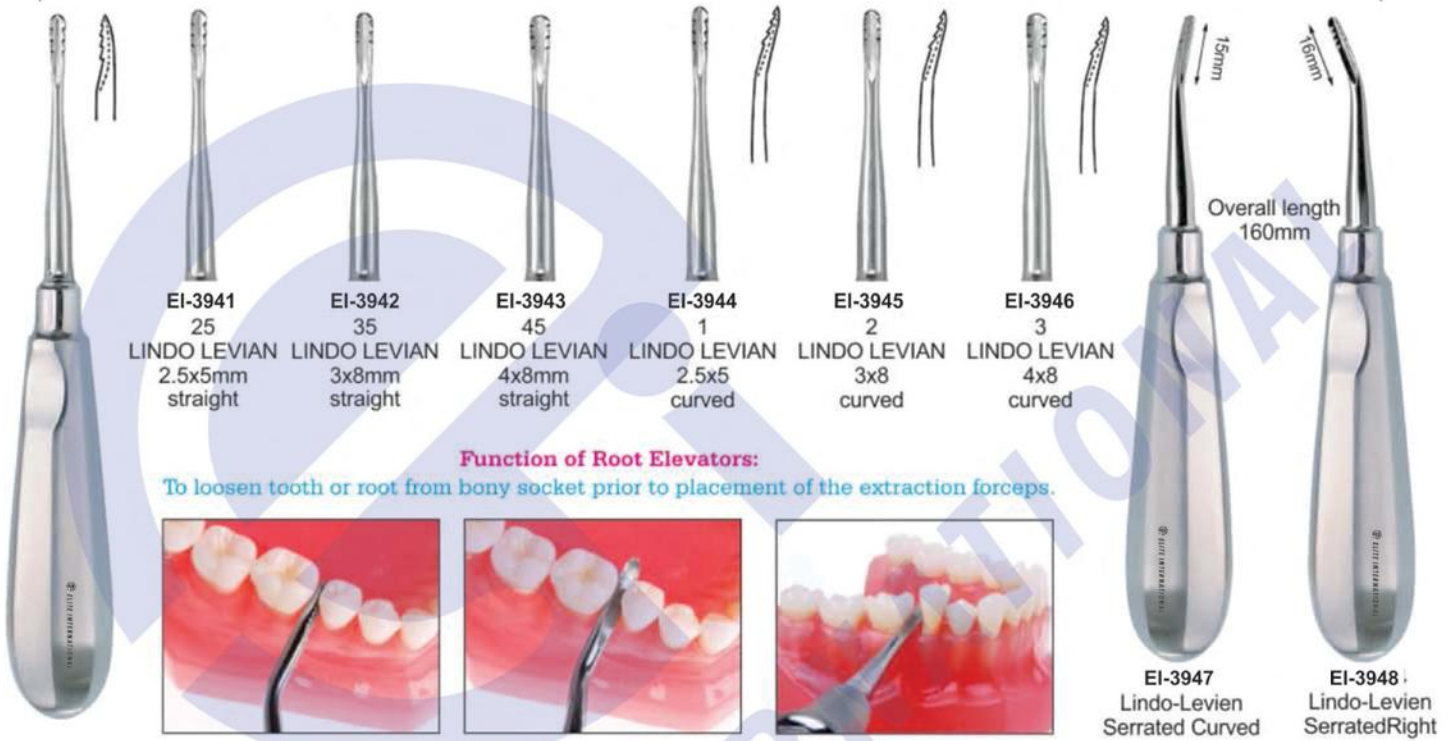

ROOT ELEVATOR

- Элеватор корневой экстракционный
- Elévateurs à racines
- Wurzelheber
- Элеватор корневий екстракційний
- Elevadores para raíces
- المصاعد الجذر

Friedmann Roots Elevator



EI-3956 Friedmann 4F Str.
EI-3957 Friedmann 5F Left
EI-3958 Friedmann 6F Right

Luxating Elevator With Periotome Tip



EI-3959 3mm Luxating Elevator / Periotome
EI-3960 4mm Luxating Elevator / Periotome
EI-3961 5mm Luxating Elevator / Periotome

Wisdom Roots Elevator



EI-3962 Wisdom for 18 and 38
EI-3963 Wisdom for 28 and 48

Function of Root Elevators: To loosen tooth or root from bony socket prior to placement of the extraction forceps.

Bayonet Roots Elevator Set



EI-3964 Left
EI-3965 Right
EI-3966 bayonet
EI-3967 Curved
EI-3968 Straight

ROOT ELEVATOR

- Элеватор корневой экстракционный
- Elévateurs à racines
- Wurzelheber
- Слеватор корневий экстракційний
- Elevadores para raices
- المصاعد الجذر

Miller Root Elevators



Function of Root Elevators: To loosen tooth or root from bony socket prior to placement of the extraction forceps.

Claw-Lift Roots Elevator



Schlemmer Roots Elevator



ROOT ELEVATOR

- Элеватор корневой экстракционный
- Elévateurs à racines
- Wurzelheber
- Слеватор корневий экстракційний
- Elevadores para raices
- المصاعد الجذر

FUNCTION: To Loosen Tooth or Root From Bony Socket Prior to Placement of The Extraction Forceps.

Laxutor Root Elevators Set of 9 Pcs



EI-3978
2mm Str.



EI-3979
3mm Str.



EI-3980
5mm Str.



EI-3981
3mm Cvd.



EI-3982
5mm Cvd.



EI-3983
3mm Angle



EI-3984
3mm Angle



EI-3985
3mm Str.



EI-3986
5mm Str.



ROOT ELEVATOR

- Элеватор корневой экстракционный
- Elévateurs à racines
- Wurzelheber
- Слеватор корневий экстракційний
- Elevadores para raices
- المصاعد الجذر

Hysin Roots Elevator



Function of Root Elevators: To loosen tooth or root from bony socket prior to placement of the extraction forceps.

Kopp Roots Elevator

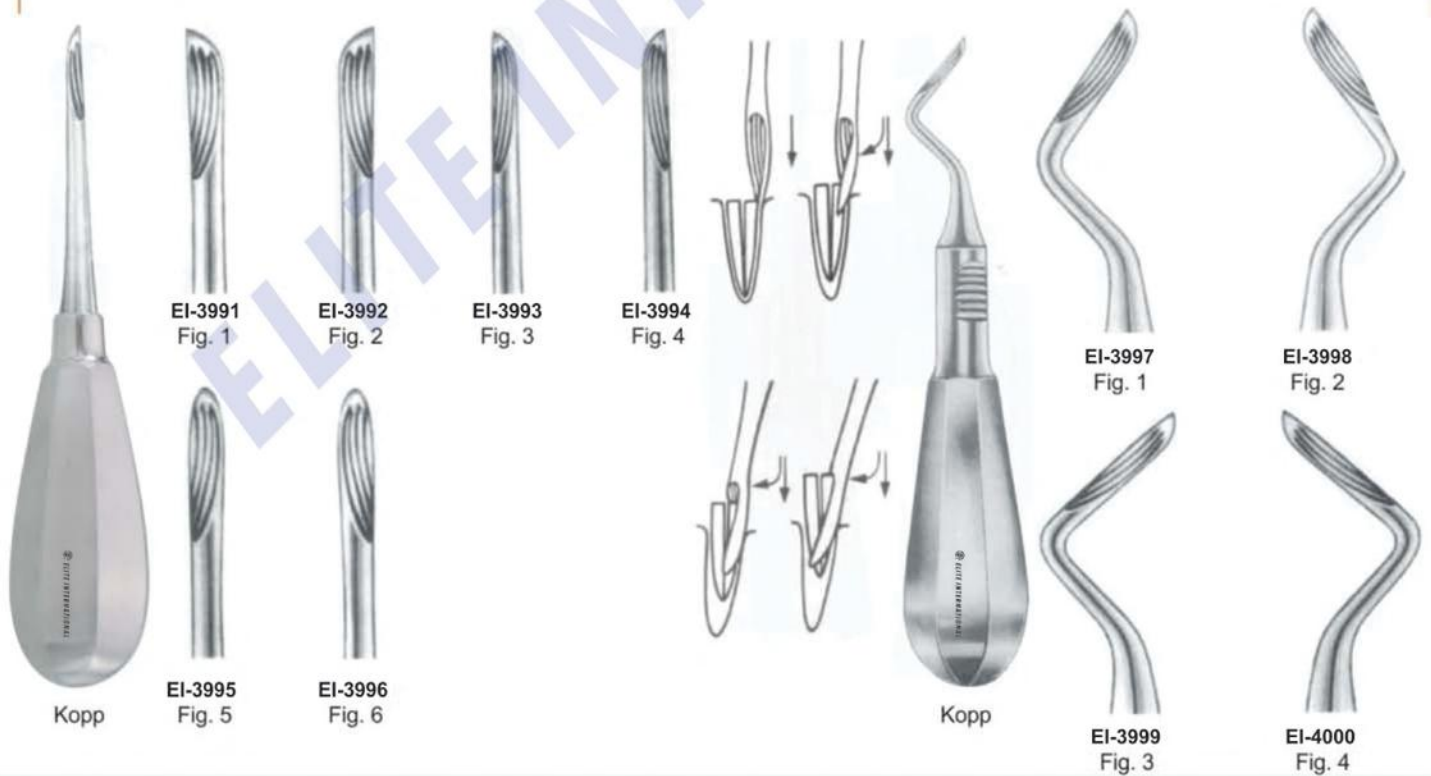

ROOT ELEVATOR

- Элеватор корневой экстракционный
- Elévateurs à racines
- Wurzelheber
- Слеватор корневий экстракційний
- Elevadores para raices
- المصاعد الجذر

Luxier Roots Elevator



EI-4001
Luxier
Cvd.

EI-4002
Luxier
Str.

Heber Roots Elevator



EI-4003
Heber
Bayonet

EI-4004
Heber
Bayonet

Bein Roots Elevator



EI-4005
Bein,
3mm

EI-4006
Bein,
4mm

Function of Root Elevators: To loosen tooth or root from bony socket prior to placement of the extraction forceps.

Bein Roots Elevator



ROOT ELEVATOR

- Элеватор корневой экстракционный
- Elévateurs à racines
- Wurzelheber
- Слеватор корневий экстракційний
- Elevadores para raices
- المصاعد الجذر

W. Barry Roots Elevator



Function of Root Elevators: To loosen tooth or root from bony socket prior to placement of the extraction forceps.



ROOT ELEVATOR

- Элеватор корневой экстракционный
- Elévateurs à racines
- Wurzelheber
- Слеватор корневий екстракційний
- Elevadores para raices
- المصاعد الجذر



EI-4036
Fig. 1
Chompret



EI-4037
Fig. 2
Chompret



EI-4038
Fig. 3
Chompret



EI-4039
Fig. 4
Chompret



Lecluse elevator for lower third molar dislocation



Chompret syndesmotome, sickle pattern



EI-4040



EI-4041



EI-4042



EI-4043



EI-4044



EI-4045



EI-4046

Root Pick Elevator With Gold Flexible Points

ROOT ELEVATOR

- Элеватор корневой экстракционный
- Elévateurs à racines
- Wurzelheber
- Слеватор корневий экстракційний
- Elevadores para raices
- المصاعد الجذر

Heidbrink Roots Elevator



EI-4047 Heidbrink Straight
 EI-4048 Heidbrink Left
 EI-4049 Heidbrink Right
 EI-4050 Heidbrink Straight
 EI-4051 Heidbrink Left
 EI-4052 Heidbrink Right

Syndesmotomes Roots Elevator



EI-4053 Straight
 EI-4054 Left
 EI-4055 Right

Periotome Roots Elevator



EI-4056 Periotome 2.1mm Straight
 EI-4057 Periotome 2.6mm Straight
 EI-4058 Periotome 2.1mm Angular
 EI-4059 Periotome 2mm Curved
 EI-4060 Periotome 2.0mm
 EI-4061 Periotome 2.5mm
 EI-4062 Periotome 3.0mm
 EI-4063 Periotome 4.0mm

Syndesmotomes

ROOT ELEVATOR

- Элеватор корневой экстракционный
- Слеватор корневий экстракційний
- Elévateurs à racines
- Elevadores para raíces
- Wurzelheber
- المصاعد الجذر

FUNCTION: To loosen small root fragments from bony socket

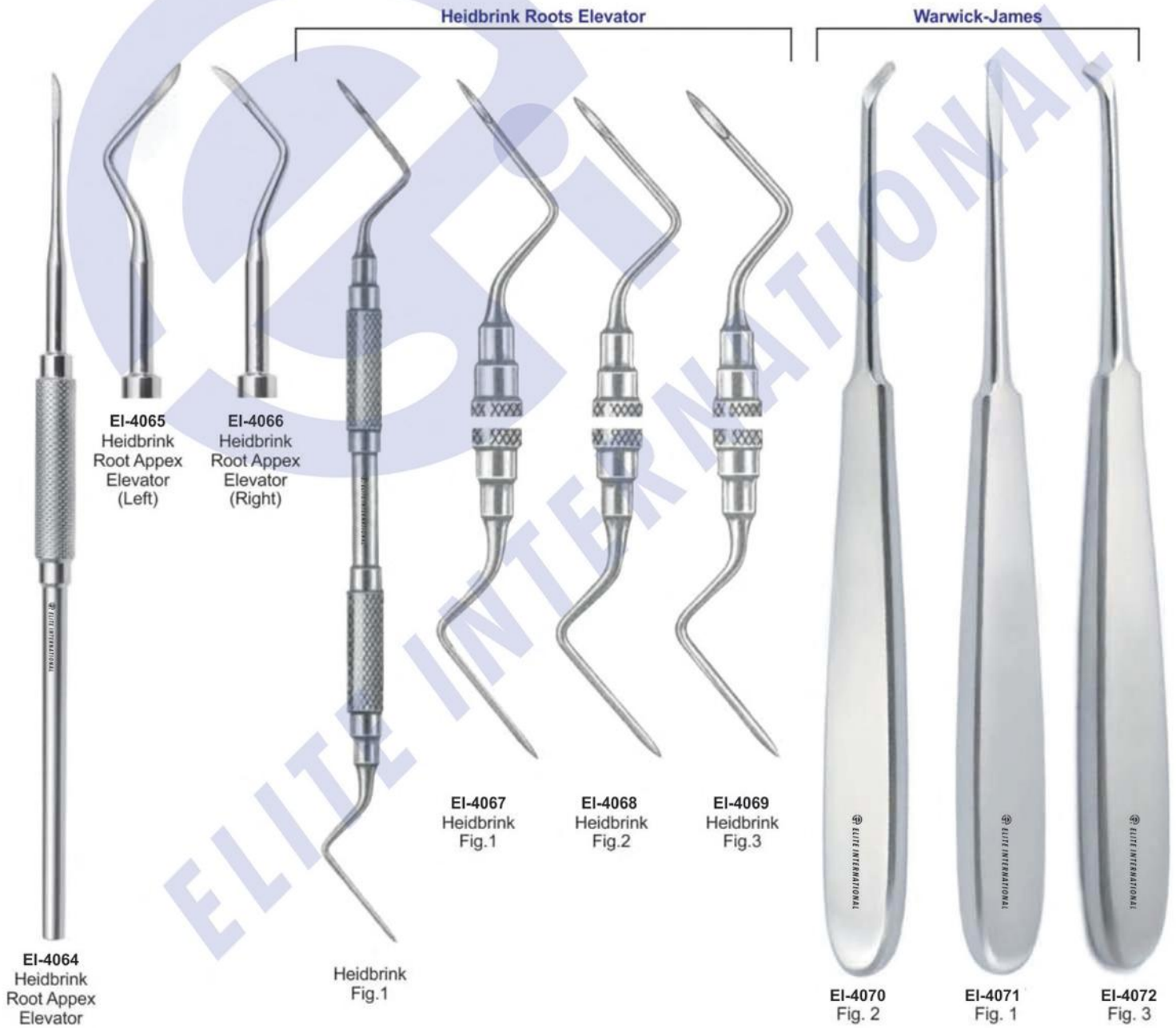

ROOT ELEVATOR

- Элеватор корневой экстракционный
- Elévateurs à racines
- Wurzelheber
- Слеватор корневий екстракційний
- Elevadores para raices
- المصاعد الجذر



EI-4073
1S
(Straight 1mm)



EI-4074
2S
(Straight 2mm)



EI-4075
3S
(Straight 3mm)



EI-4076
5S
(Straight 5mm)



EI-4077
3C
(Curved 3mm)



EI-4078
5C
(Curved 5mm)



EI-4079
3CA
(Curved Angle 3mm)



EI-4080
3IC
(Inverted Curved 3mm)



EI-4081
DE 3
(Dual Edge 3mm / 1.5mm)



EI-4082
DE 5
(Dual Edge 5mm / 3mm)

ROOT ELEVATOR

- Элеватор корневой экстракционный
- Elévateurs à racines
- Wurzelheber
- Єлеватор кореневий екстракційний
- Elevadores para raíces
- المصاعد الجذر



EI-4083
Luxators Set of 7 Pcs



EI-4084
Luxators Set of 7 Pcs



EI-4085
Luxators Set of 8 Pcs



EI-4086
Root Elevators Set of 10 Pcs



EI-4087
Elevators Set of 8 Pcs



EI-4088
Elevators Set of 8 Pcs

ROOT ELEVATOR

- Элеватор корневой экстракционный
 - Elévateurs à racines
 - Wurzelheber
- Слеватор корневий екстракційний
 - Elevadores para raices
 - المصاعد الجذر

PDL ELEVATORS



EI-4089
PDL Elevators
Set of 7 Pcs



EI-4090
PDL Elevators
Set of 7 Pcs

ROOT ELEVATOR

- Элеватор корневой экстракционный
- Elévateurs à racines
- Wurzelheber
- Слеватор корневий экстракційний
- Elevadores para raices
- المصاعد الجذر

PDL ELEVATORS

Delicate Arrow tip



4,0mm straight
4,0mm curved

Luxivators straight
atraumatic luxation of the tooth



2,5mm straight
3,5mm straight
4,5mm straight

Luxivators curved
atraumatic luxation of the tooth



2,5mm curved
3,5mm curved
4,5mm curved



EI-4091
PDL Elevators
Set of 8 Pcs

Our Scalers

Compare our scalers and curettes with the best in the industry and you will immediately recognize we are equal in every way but one... price. Note the deep precision knurling for better tactile feel. The same high-grade stainless steel tips, the same light weight (under 18 grams) for less hand fatigue, the same professional craftsmanship, and surpassing the highest industry standards. of course, any manufacturer can make these claims, but we guarantee and certify ours.

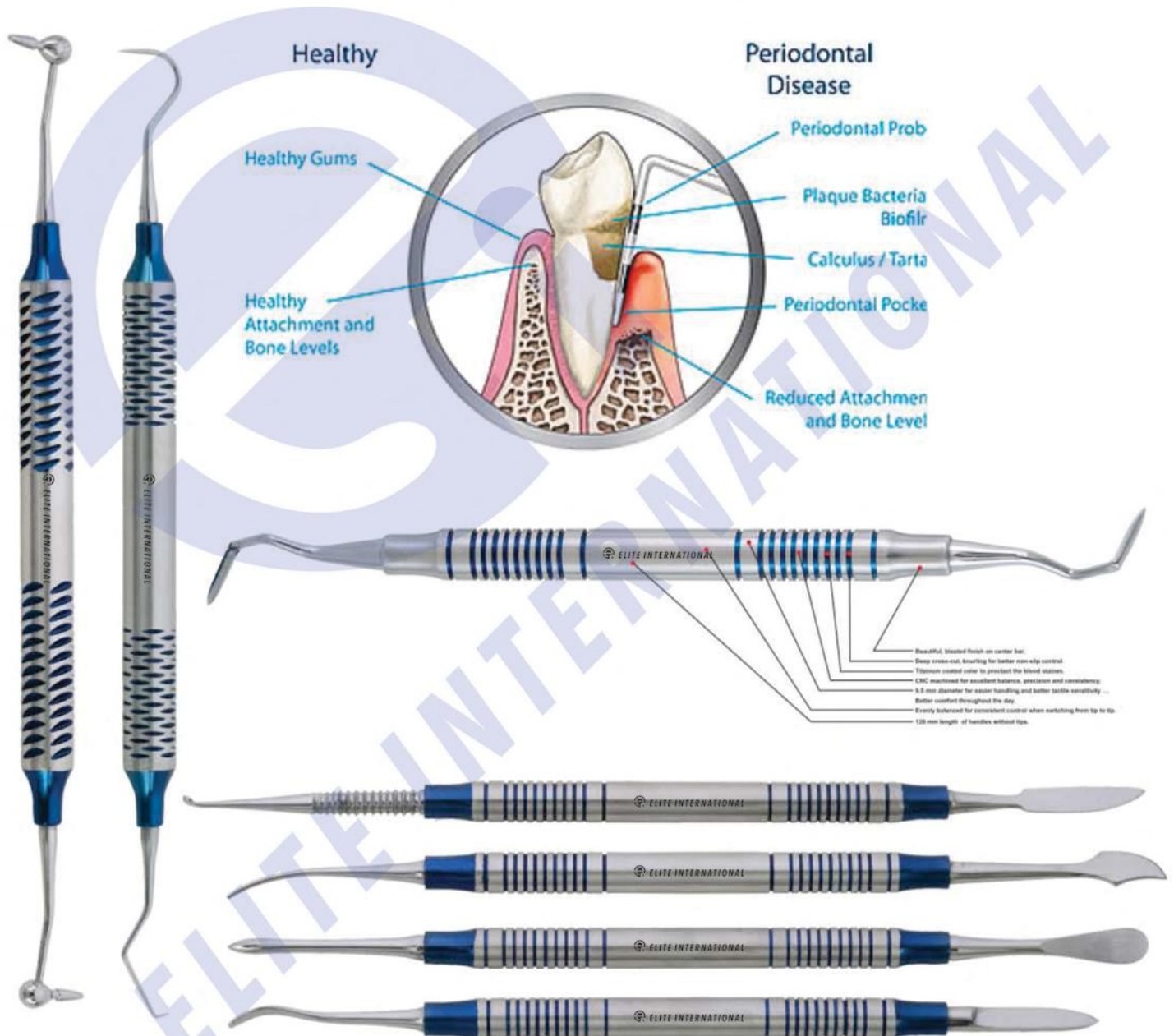

- High-polish mirror finish tips.
- Manufactured within the guidelines of the FDA quality assurance system for good manufacturing practices.
- Highest grade German stainless steel, razor sharp, durable tips. Rockwell hardened to 60 RHc.
- 27 of the most popular designs from graces to McCalls to columbias, and many european patterns.
- All instruments are guaranteed against defects in material and workmanship.

- All instruments bear the CE mark, emblematic of the european community's highest standards.
- Customer satisfaction guarantee, too!
- Less than 20 grams ... Lightweight for less hand fatigue.
- Manufactured to the most exacting standards so the 50th instrument you buy is exactly like your first.
- You decide ... Why pay more for the same high-quality instruments?

DIAGNOSTIC, PERIODONTAL & RESTORATIVE INSTRUMENTS

VALUED BUYERS

Compare our scalers and curettes with the best in the industry and you will immediately recognize we are equal in every way but one... price. Note the deep precision knurling for better tactile feel. The same high-grade stainless steel tips, the same light weight (under 20 grams) for less hand fatigue, the same professional craftsmanship, and surpassing the highest industry standards. Of course, any manufacturer can make these claims, but we guarantee and certify ours. We regularly manufacturing below articles in showing handles & pattern A to L for better grip & perfection. We are also fully equipped & capable to develop these instruments as per your own specific requirements & demands in materials, sizes, shapes and patterns.



A-Hollow Handle Ø 10 mm



B-Hollow Handle Ø 10 mm



C-Hollow Handle Ø 10 mm



D-Hollow Handle Ø 10 mm



E-Hollow Handle Ø 10 mm



F-Hollow Handle Ø 10 mm



G-Hollow Handle Ø 10 mm



H-Hollow Handle Ø 6.4 mm



I-Hollow Handle Ø 8 mm



J-Hollow Handle Ø 10 mm



K-Soild Handle Ø 6 mm



L-Soild Handle Ø 6 mm

MOUTH MIRRORS

- зеркала
- Espejos de la boca
- Mundspiegel
- дзеркала
- Miroirs à la bouche
- مرايا الفم

Plain

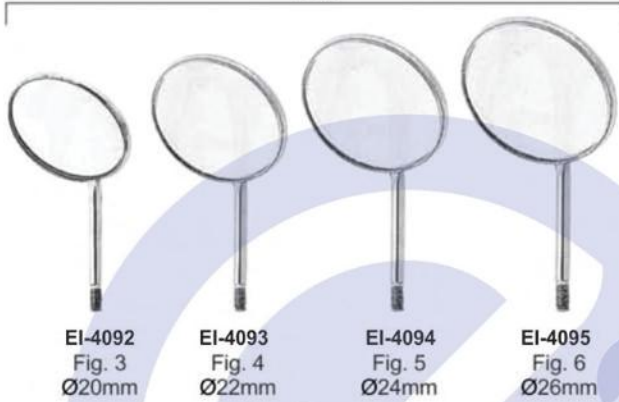

Cone-Socket Plain



Magnifying

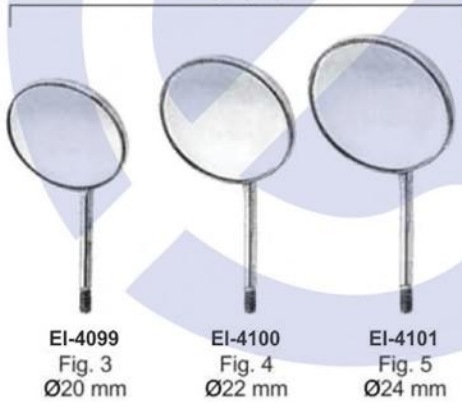

Cone-Socket Magnifying

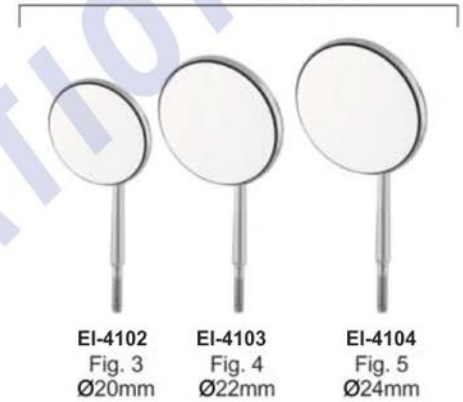

Rhodium



Cone-Socket Rhodium



Front Surface



Cone-Socket Front Surface



HANDLES FOR MOUTH MIRRORS

- Ручки для зеркал
- Manches pour miroirs à bouche
- Mundspiegelgriffe
- Ручки для дзеркал
- Mangos para espejos de boca
- مقابض لعرايا الفم



EI-4118
Hollow Mirror
Handle Round
Ø 10 mm



EI-4119
Hollow Mirror
Hexagonal
Handle
Ø 8 mm



EI-4120
Hollow
Ø 8 mm



EI-4121
Hollow Mirror
Hexagonal
Handle
Ø 10 mm



EI-4122
Hollow Mirror
Handle
Ø 8 mm



EI-4123
Hollow Mirror
Handle
Ø 10 mm



EI-4124
Mirror Handle
Solid
Ø 6 mm



EI-4125
Mirror Handle
Solid
Ø 6 mm



EI-4126
Mirror Handle
Solid Octagonal
Ø 6 mm



EI-4127
Mirror Handle
Stem
with Rule
35mm



EI-4128
Mirror Handle
Solid
Stem with
Rule 35mm



EI-4129
Cone-Socket
Solid Octagonal
Ø 6 mm



EI-4130
Cone-socket
Solid
Ø 6 mm



EI-4131
Cone-socket
Hexagonal
Handle
Ø 6 mm

Cone-Socket Mirror Handle

EXPLORERS

- Зонды
 - Sondes
 - Zahnsonden
- Зонди
 - Sondas
 - المستكشفين

Examination kit Set of 3 Pieces



EI-4132 Probe
EI-4133 Mirror
EI-4134 College Forcep 15cm

Examination Set of 4 Pieces



EI-4135 Exp, 23/17-A
EI-4136 Exavators
EI-4137 Tweezers
EI-4138 Mouth Mirror

EI-4139

First Aid Examination Set of 3 Pieces



EI-4140

First Aid Examination Set of 3 Pieces



EI-4141

First Aid Examination Set of 3 Pieces



EI-4142

First Aid Examination Set of 3 Pieces



TWEEZERS

- Пинцеты
- Précelles - Brucelles
- Zahnpinzetten

- Пинцети
- Pinzas para algodón
- ملاقط



EI-4143
Surgical
11.5cm



EI-4144
London College
15cm



EI-4145
Semken Taylor
Str.



EI-4146
Semken Taylor
Cvd.



EI-4147
Meriam
16cm



EI-4148
Dressing
14cm



EI-4149
Semken Taylor
1x2 Straight



EI-4150
Semken Taylor
1x2 Curved



EI-4151
Gilles
15cm 1x2



EI-4152
14cm 1x2



EI-4153
Perry
13cm



EI-4154
Atraumatic
15cm Cvd



EI-4155
Atraumatic
15cm Str.



EI-4156
College with Lock
15cm Cvd.



EI-4157
Gerald
17.5cm



EI-4158
with lock
15cm



EI-4159
Atraumatic
17.5cm

TWEEZERS

- Пинцеты
- Précelles - Brucelles
- Zahnpinzetten

- Пінцети
- Pinzas para algodón
- ملاقط



EI-4160
Adson-TC
12cm



EI-4161
Adson-TC
12cm 1x2



EI-4162
Adson-TC
15cm 1x2



EI-4163
Adson
12cm



EI-4164
Adson
12cm 1x2



EI-4165
Adson
15cm 1x2



EI-4166
Adson Brown
12cm



EI-4167
Crane Kaplan
15cm



EI-4168
Crane Kaplan
15cm



EI-4169
Crane Kaplan
15cm



EI-4170
Hemingway
15cm



EI-4171
Miller
15cm Str.



EI-4172
Miller
15cm Cvd.



EI-4173
Dressing
Tweezer
14.5cm



EI-4174
College
Curved
Tip 15cm



EI-4175
Maryam
Tweezers
15cm



EI-4176
College
Tweezer
15cm



EI-4177
Perry
Tweezer
12.5cm



EI-4178
Self-locking
Tweezer
15cm

EXPLORERS

- Зонды
- Sondes
- Zahnsonden
- Зонди
- Sondas
- المستكشفين

Single Ended Probe Solid Handle 4.5mm Length 150mm

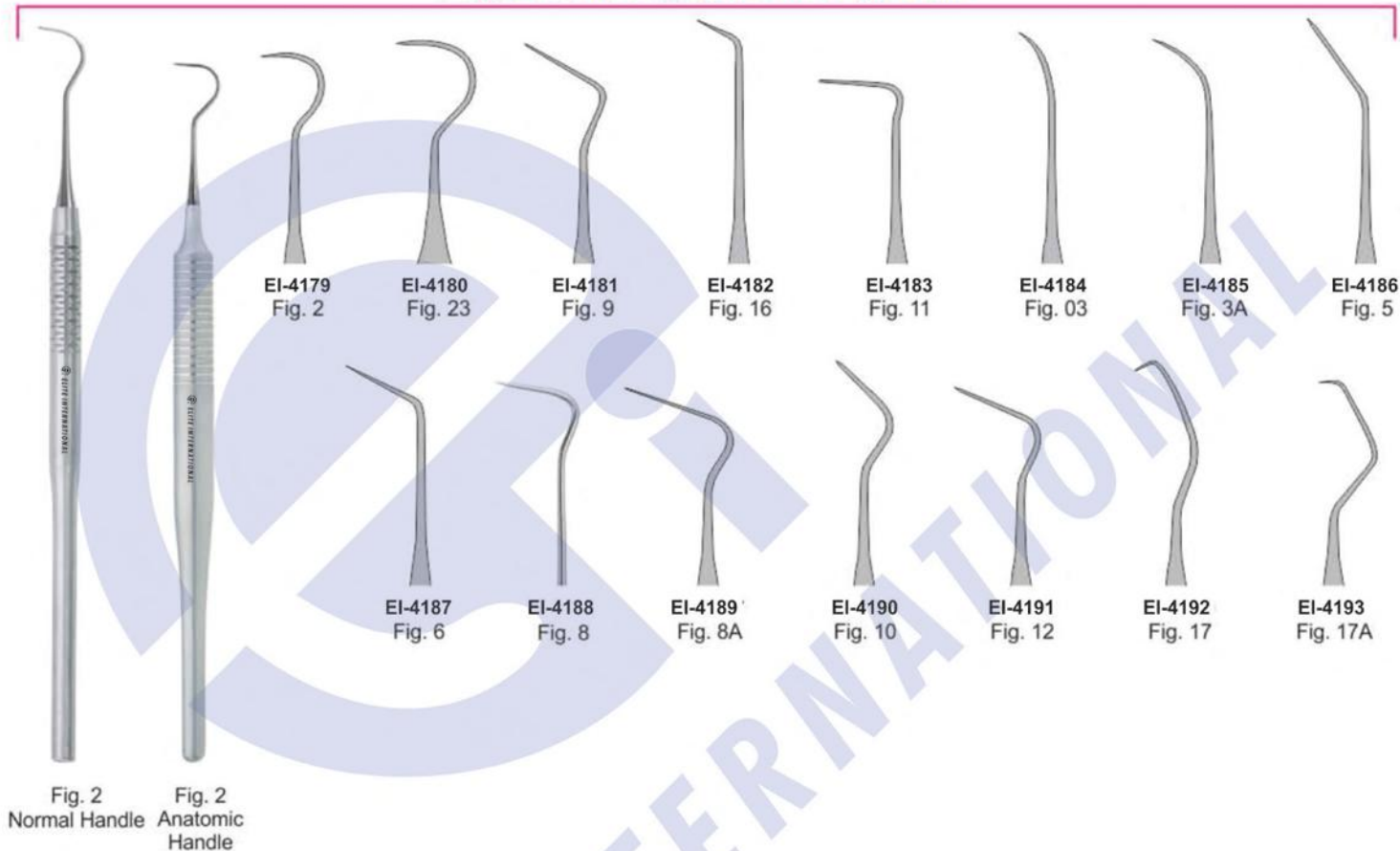

Explorers-Single-End

Double-Ended Explorers

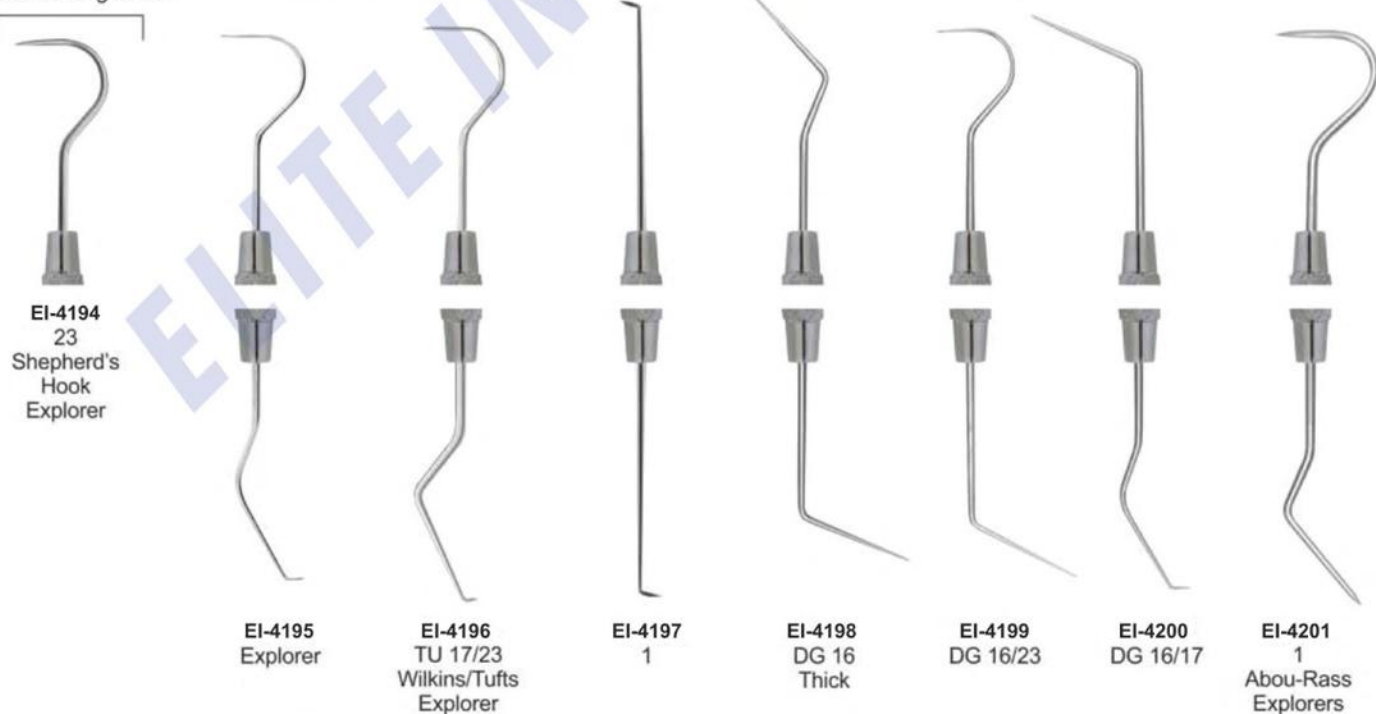

EXPLORERS

- Зонды
 - Sondes
 - Zahnsonden
- Зонди
 - Sondas
 - المستكشفين

Probes Double Ended 6mm, length 170mm

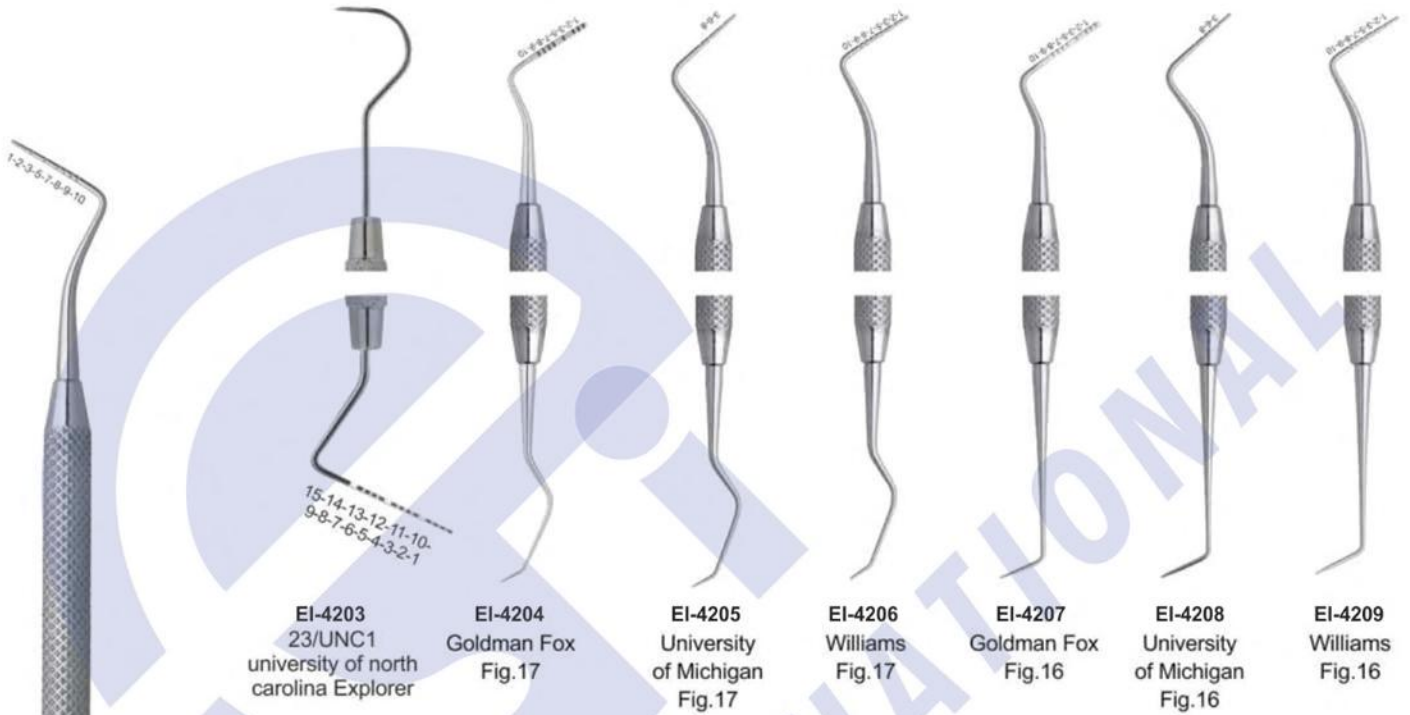

Pointed Probes Double Ended Handle 6mm, length 170mm



EXPLORERS

- Зонды
- Sondes
- Zahnsonden
- Зонди
- Sondas
- المستكشفين

EXPLORERS INSTRUMENTS SOLID HANDLE 6MM, LENGTH 170MM

PLUGGERS

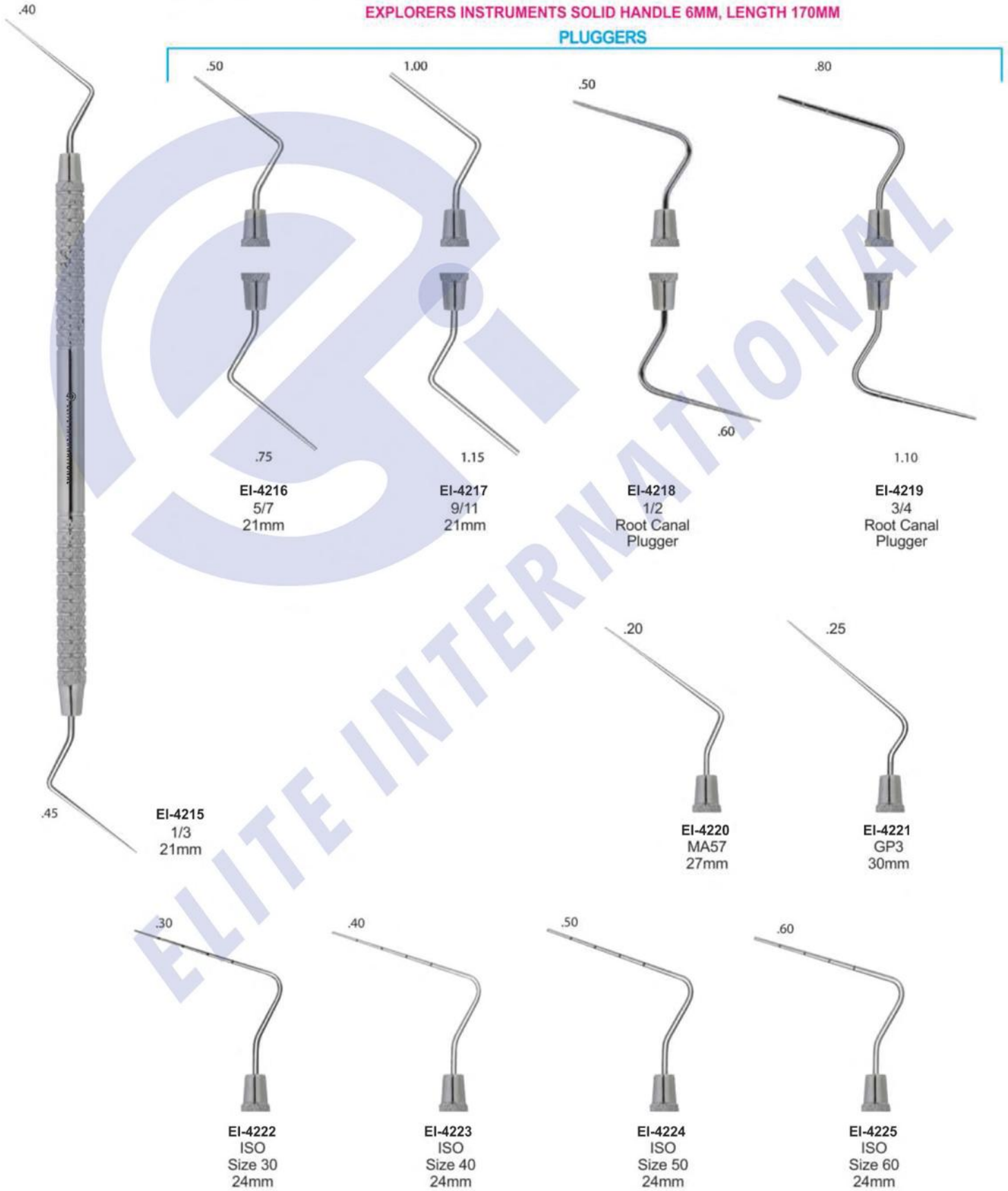

PERIODONTAL PROBES

- Зонды пародонтологические
 - Sondes parodontales
 - sonda parodontall
- зонди пародонтологічні
 - Sondas parodontales
 - المسابر اللثة

SPREADERS

HEAT CARRIERS

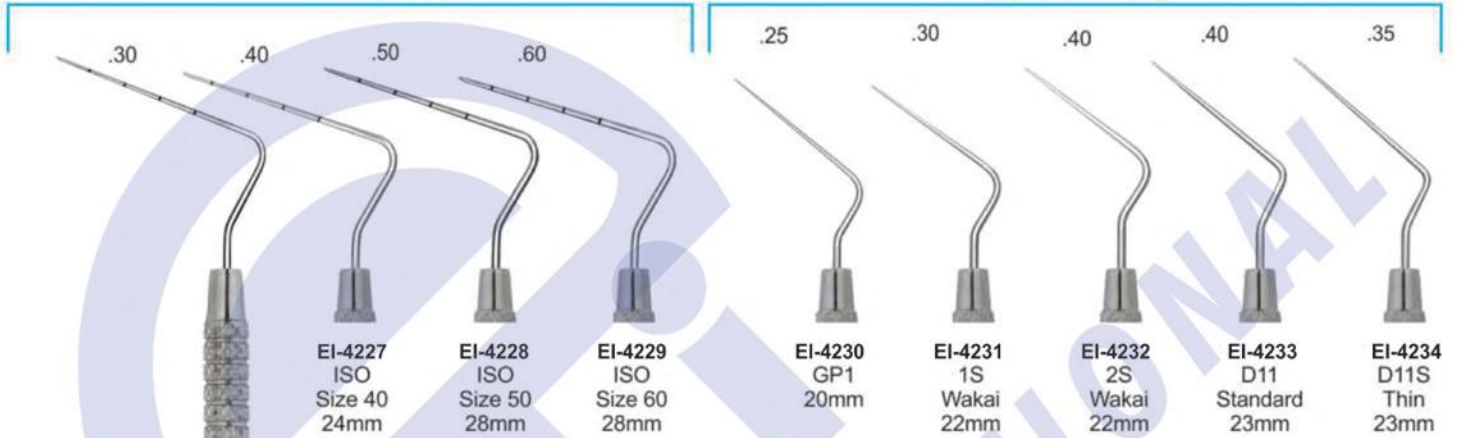

HEAT CARRIERS



PERIODONTAL PROBES

- Зонды пародонтологические
- Sondes paradontales
- sonda paradontali
- зонди пародонтологічні
- Sondas paradontales
- المسابر اللثة

ENDODONTICS INSTRUMENTS

ANTERIOR

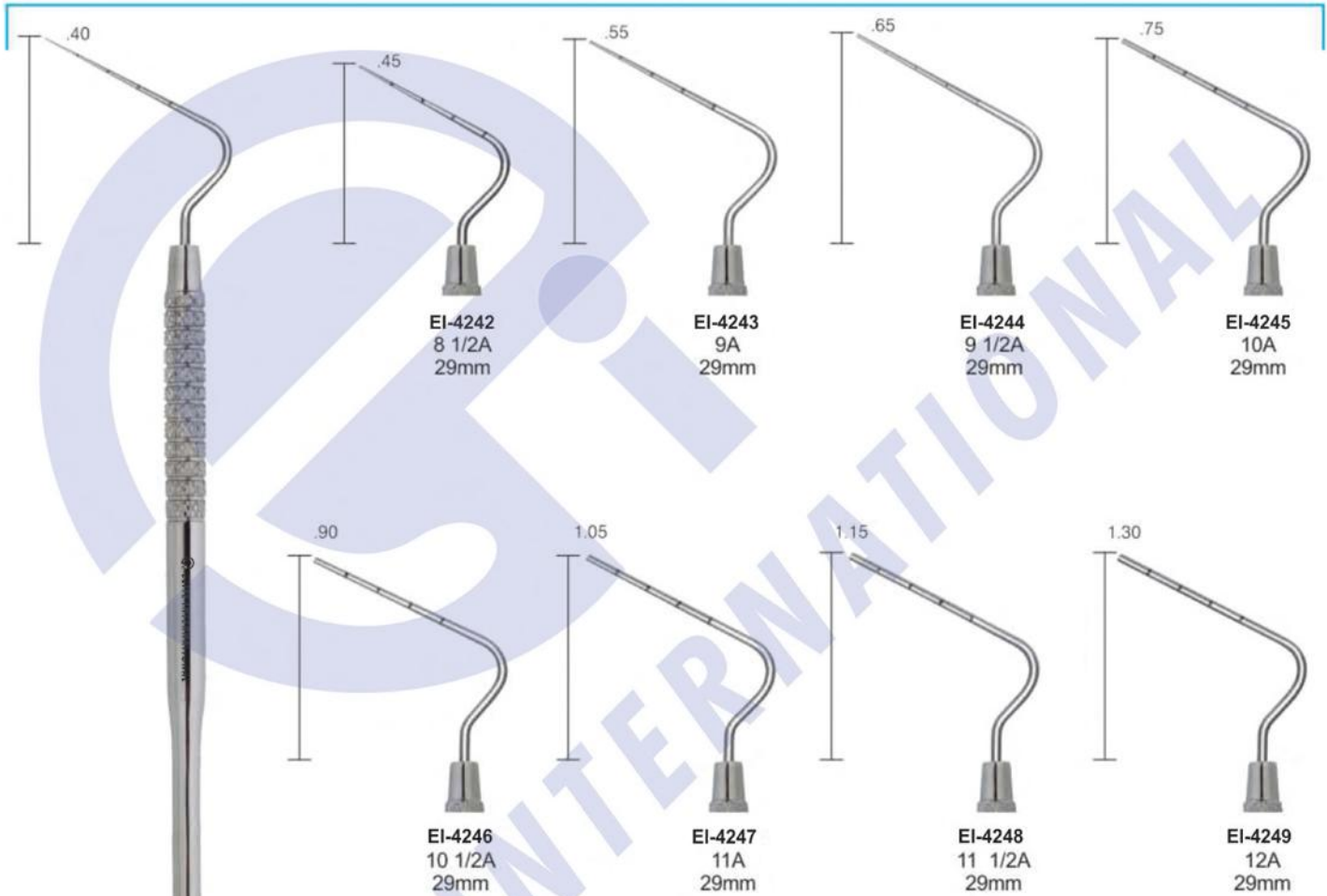

LUKS

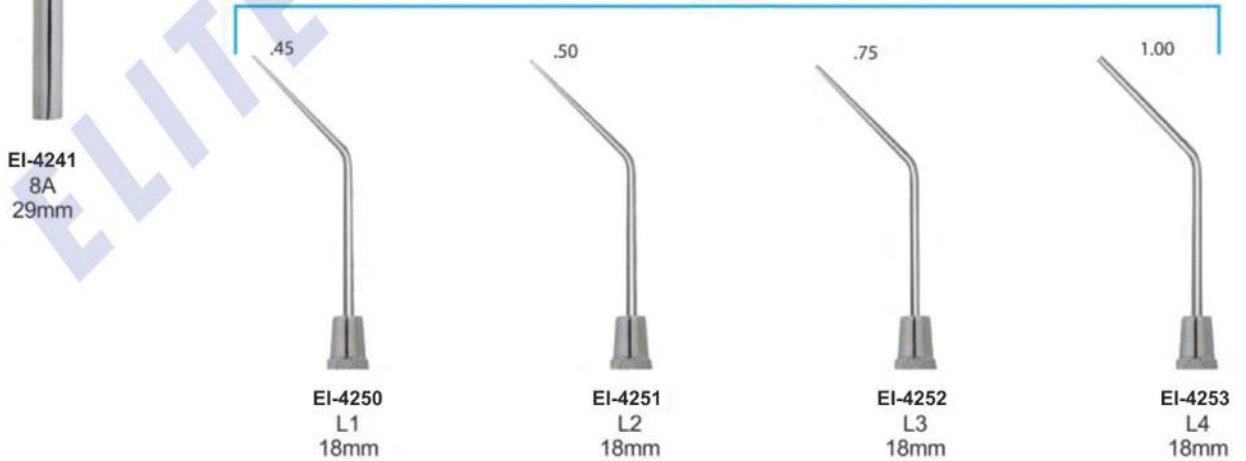

SCALER



EI-4254
Gracey Currettes 1/2



EI-4255
Gracey Currettes 3/4



EI-4256
Gracey Currettes 5/6



EI-4257
Gracey Currettes 7/8



EI-4258
Gracey Currettes 9/10



EI-4259
Gracey Currettes 11/12



EI-4260
Gracey Currettes 13/14



EI-4261
Gracey Currettes 1/2



EI-4262
Gracey Currettes 3/4



EI-4263
Gracey Currettes 5/6



EI-4264
Gracey Currettes 7/8



EI-4265
Gracey Currettes 9/10



EI-4266
Gracey Currettes 11/12



EI-4267
Gracey Currettes 13/14



HANDLES FOR MOUTH MIRRORS

- Ручки для зеркал
- Manches pour miroirs à bouche
- Mundspiegelgriffe
- Ручки для дзеркал
- Mangos para espejos de boca
- مقابض لعرايا الفم



EI-4268
Hollow Mirror
Handle Round
Ø 10 mm



EI-4269
Hollow Mirror
Hexagonal
Handle
Ø 8 mm

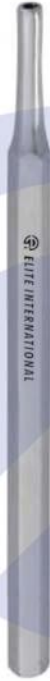

EI-4270
Hollow
Ø 8 mm



EI-4271
Hollow Mirror
Hexagonal
Handle
Ø 10 mm



EI-4272
Hollow Mirror
Handle
Ø 8 mm



EI-4273
Hollow Mirror
Handle
Ø 10 mm



EI-4274
Mirror Handle
Solid
Ø 6 mm



EI-4275
Mirror Handle
Solid
Ø 6 mm



EI-4276
Mirror Handle
Solid Octagonal
Ø 6 mm



EI-4277
Mirror Handle
Stem
with Rule
35mm



EI-4278
Mirror Handle
Solid
Stem with
Rule 35mm



EI-4279
Cone-Socket
Solid Octagonal
Ø 6 mm



EI-4280
Cone-socket
Solid
Ø 6 mm



EI-4281
Cone-socket
Hexagonal
Handle
Ø 6 mm

Cone-Socket Mirror Handle

SCALER

Sickle Scalars



EI-4282 Fig. U15/33 - Towner-Jaquette



EI-4283 Fig. U15/30 - Towner-Jaquette



EI-4284 Fig. H5/33



EI-4285 Fig. H6/H7



EI-4286 Fig. 30/33 - Jaquette



EI-4287 Fig. T2/T3 - Taylor



EI-4288 Fig. 204



EI-4289 Fig. 204S



EI-4290 Fig. 11/12 - MC - McCall
Mesial



EI-4291 Fig. 13/14 - MC - McCall
Distal

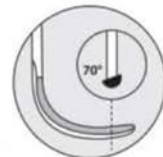
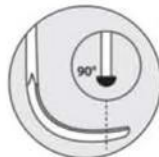
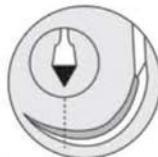
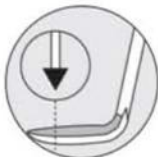

Straight and curved sickle scalars
Feature: 2 cutting edges curved facial component tipped ends

Universal curettes
are characterized by an angle of 90° between the terminal stem and the cutting component.

Gracey curettes
are characterized by an angle of 70° between the terminal stem and the cutting component.

Universal Curettes



EI-4292 Fig. 13S/14S - MC - McCall



EI-4293 Fig. 17S/18S - MC - McCall Distal



EI-4294 Fig. M23



EI-4295 Fig. 204SD



EI-4296 Fig. YG7/8-Younger Good



EI-4297 Fig. L 1/2 - Langer



EI-4298 Fig. L 3/4 - Langer



EI-4299 Fig. L 5/6 - Langer



EI-4300 Fig. M 23A



EI-4301 Fig. M 23B

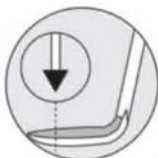

Straight and curved sickle scalers
Feature: 2 cutting edges curved facial component tipped ends

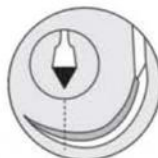

Universal curettes
are characterized by an angle of 90° between the terminal stem and the cutting component.

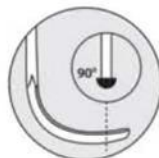

Gracey curettes
are characterized by an angle of 70° between the terminal stem and the cutting component.

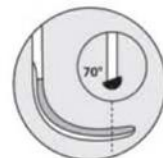

Periodontal knives





EI-4310
17



EI-4311
17D



EI-4312
54A
Mühlemann



EI-4313
67



EI-4314
37D



EI-4315
8
Wiland



EI-4316
8
Holz

0.9 MM



EI-4317
9
Holz

0.7 MM

Chisels
Diamond coated margin trimmers

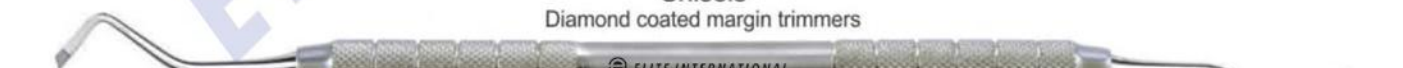

EI-4318
40P



EI-4319
40A

Thanks to the diamond-coated hand instruments the margins are evenly levelled.



Thanks to the diamond-coated hand instruments the margins are evenly levelled.

SCALER

Margin trimmers

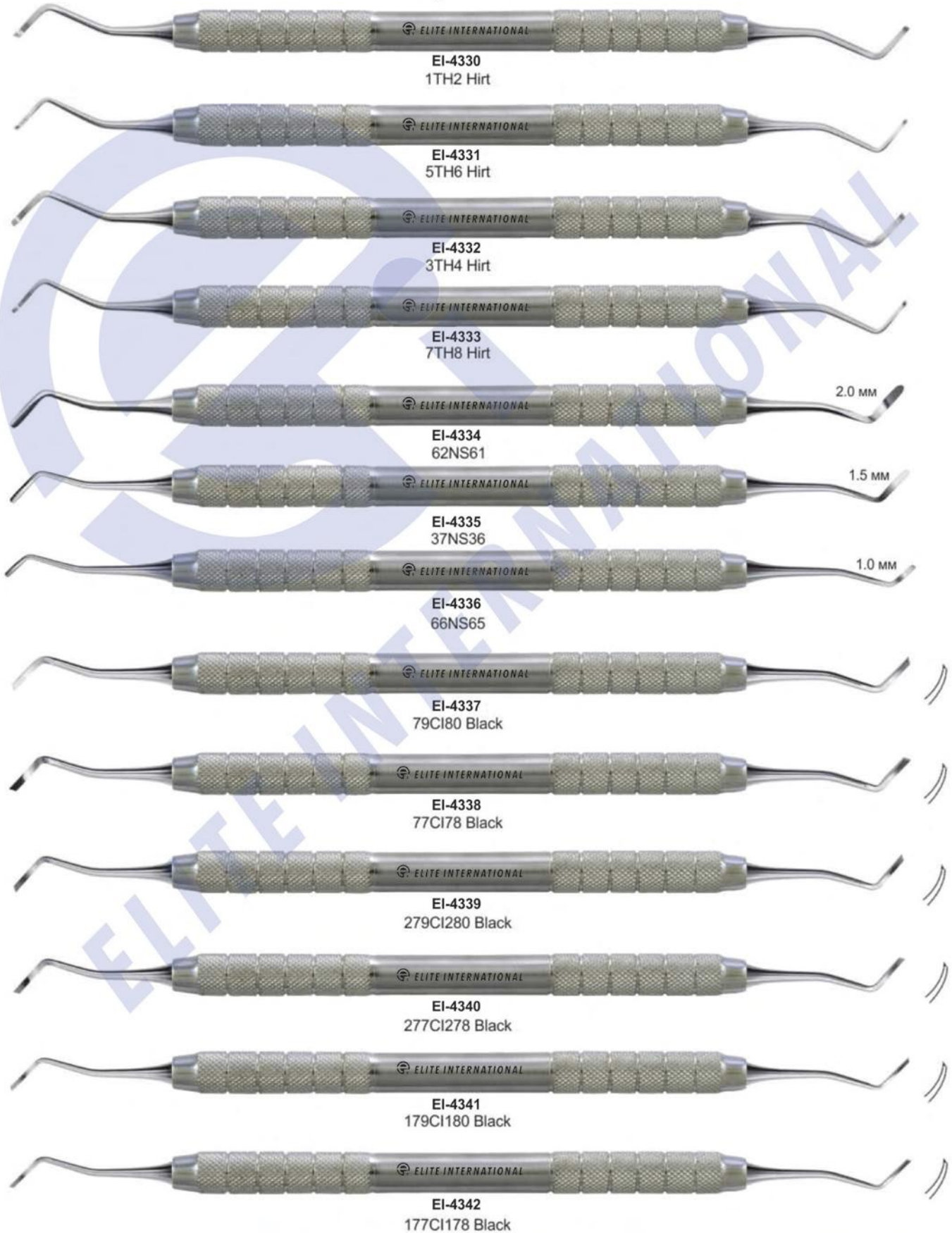

CHISELS



EI-4343
1/2 Werdelstaedt



EI-4344
3/4 Werdelstaedt



EI-4345
7 Straight

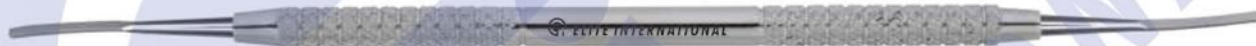

EI-4346
5/6 Straight



EI-4347
7/10 Straight



EI-4348
8/9 Binangle



EI-4349
11/12 Binangle



EI-4350
40/41 Binangle

Tartar Remover Instruments Solid Handle Ø 6 mm



EI-4351
Fig. 1



EI-4352
Fig. 1L
Left

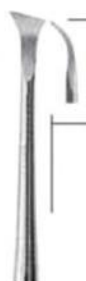

EI-4353
Fig. 1R
Right



EI-4354
Fig. 2L
left



EI-4355
Fig. 2R
Right



EI-4356



EI-4357

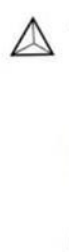

EI-4358

BURNISHERS CONSERVATIVE TREATMENT



ELITE INTERNATIONAL
EI-4359
WHITE 28



ELITE INTERNATIONAL
EI-4360
WHITE 29



ELITE INTERNATIONAL
EI-4361
WHITE 31

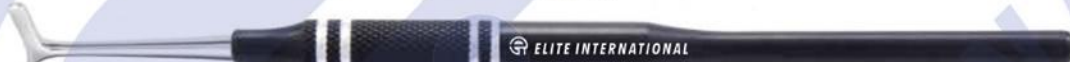

ELITE INTERNATIONAL
EI-4362
WHITE 32

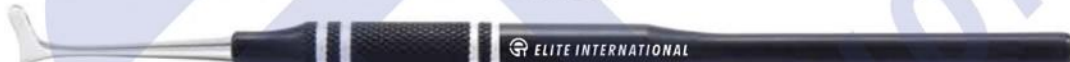

ELITE INTERNATIONAL
EI-4363
WHITE 33



ELITE INTERNATIONAL
EI-4364
WHITE 34



ELITE INTERNATIONAL
EI-4365
WESTCOTT 21



ELITE INTERNATIONAL
EI-4366
WESTCOTT 21B



ELITE INTERNATIONAL
EI-4367



ELITE INTERNATIONAL
EI-4368



ELITE INTERNATIONAL
EI-4369
WHITE



ELITE INTERNATIONAL
EI-4370
WHITE

FILLING INSTRUMENTS CONSERVATIVE TREATMENT



FILLING INSTRUMENTS CONSERVATIVE TREATMENT

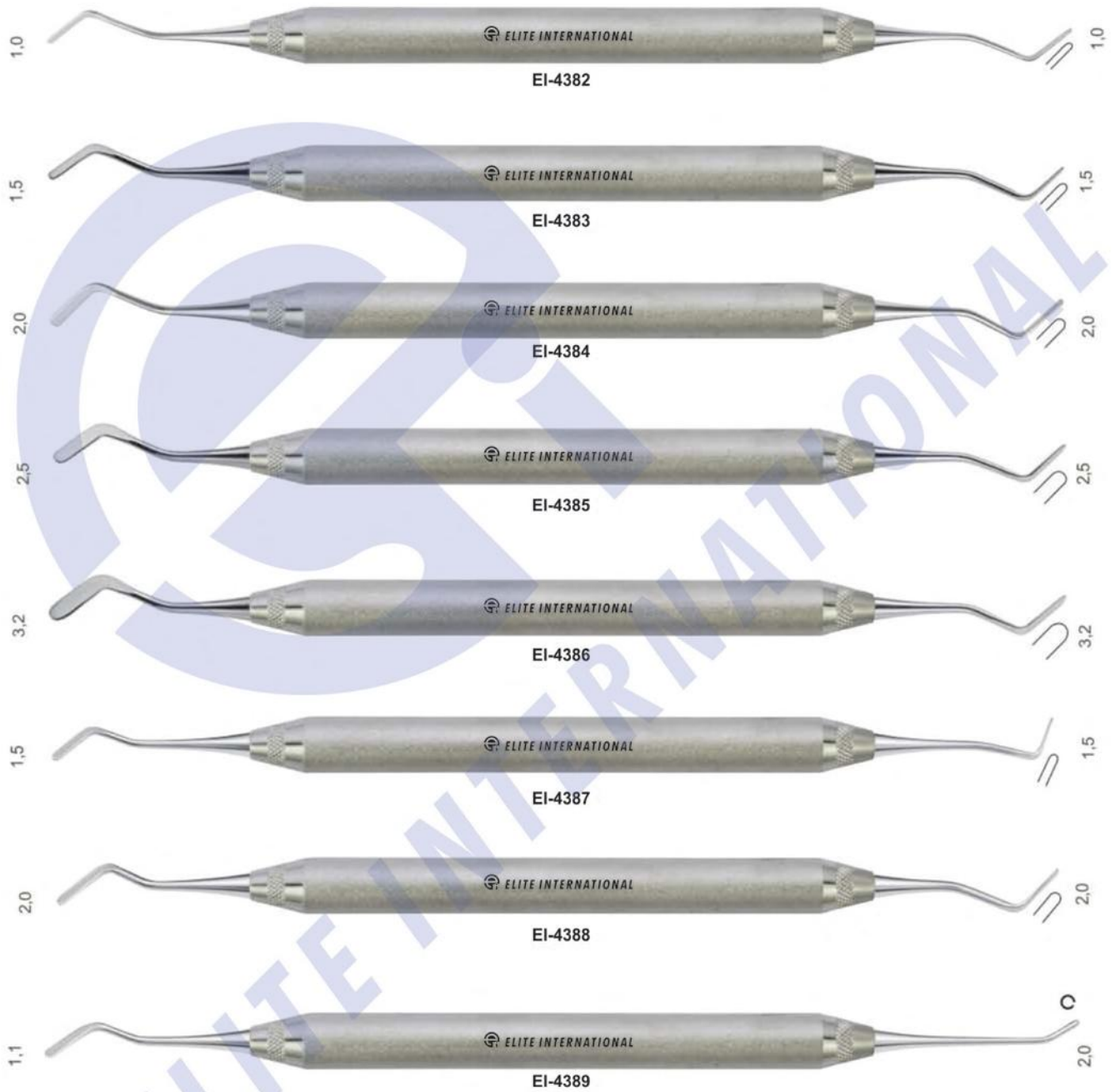

Ball Burnishers



Hatches



COMPOSITE INSTRUMENTS

Spatulas rounded and sharp



Spatulas Blade Thickness 0.22 MM

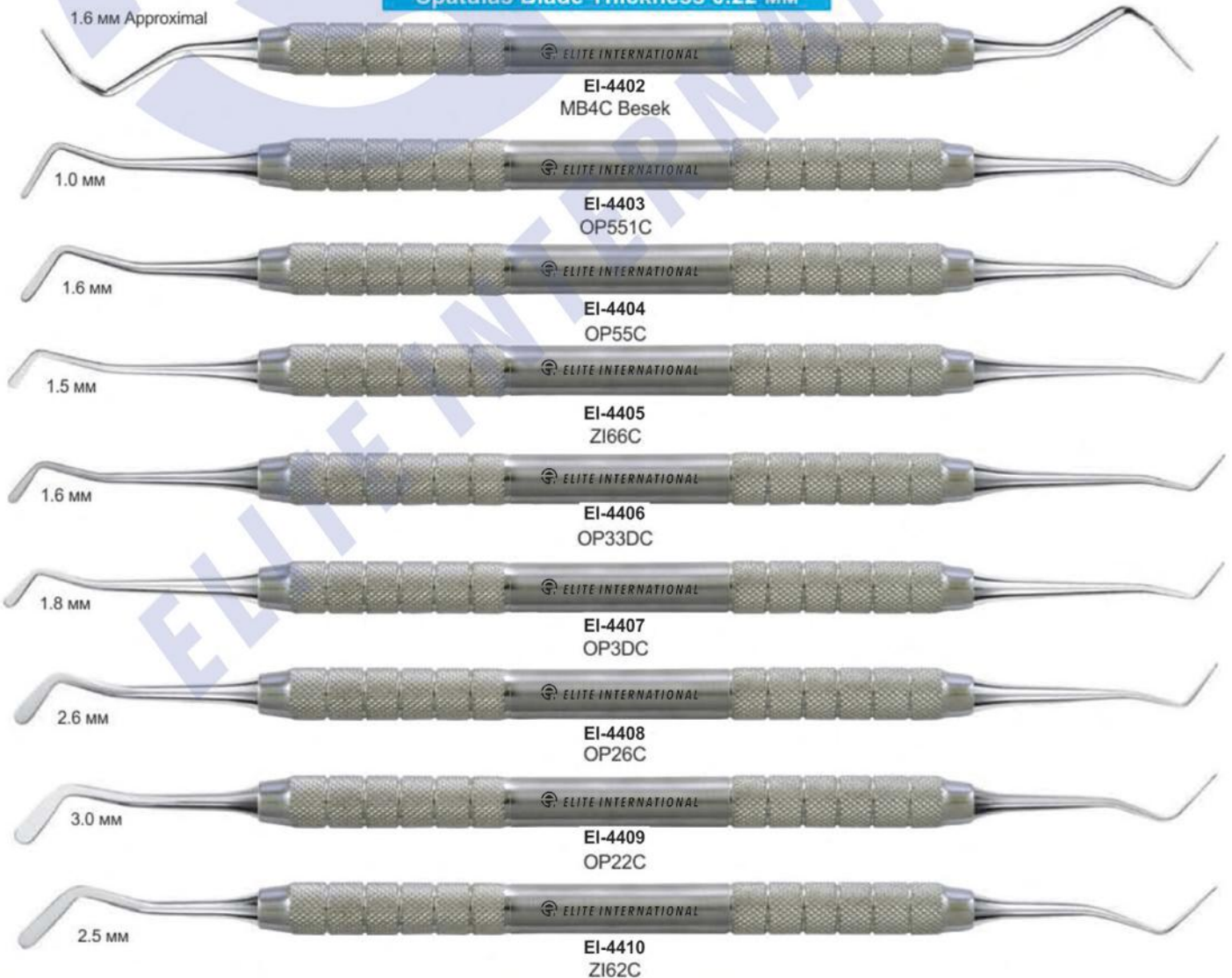

COMPOSITE INSTRUMENTS

Spatulas

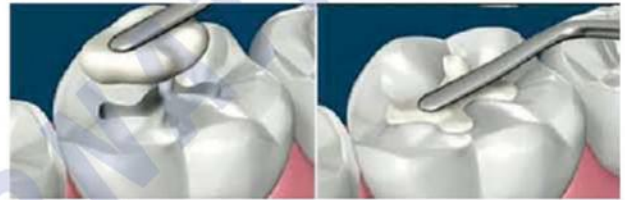

Spatulas-Pluggers



EXCAVATOR INSTRUMENTS

Water drop Our excavators have particularly sharp blades, free of burrs and perfectly rounded.

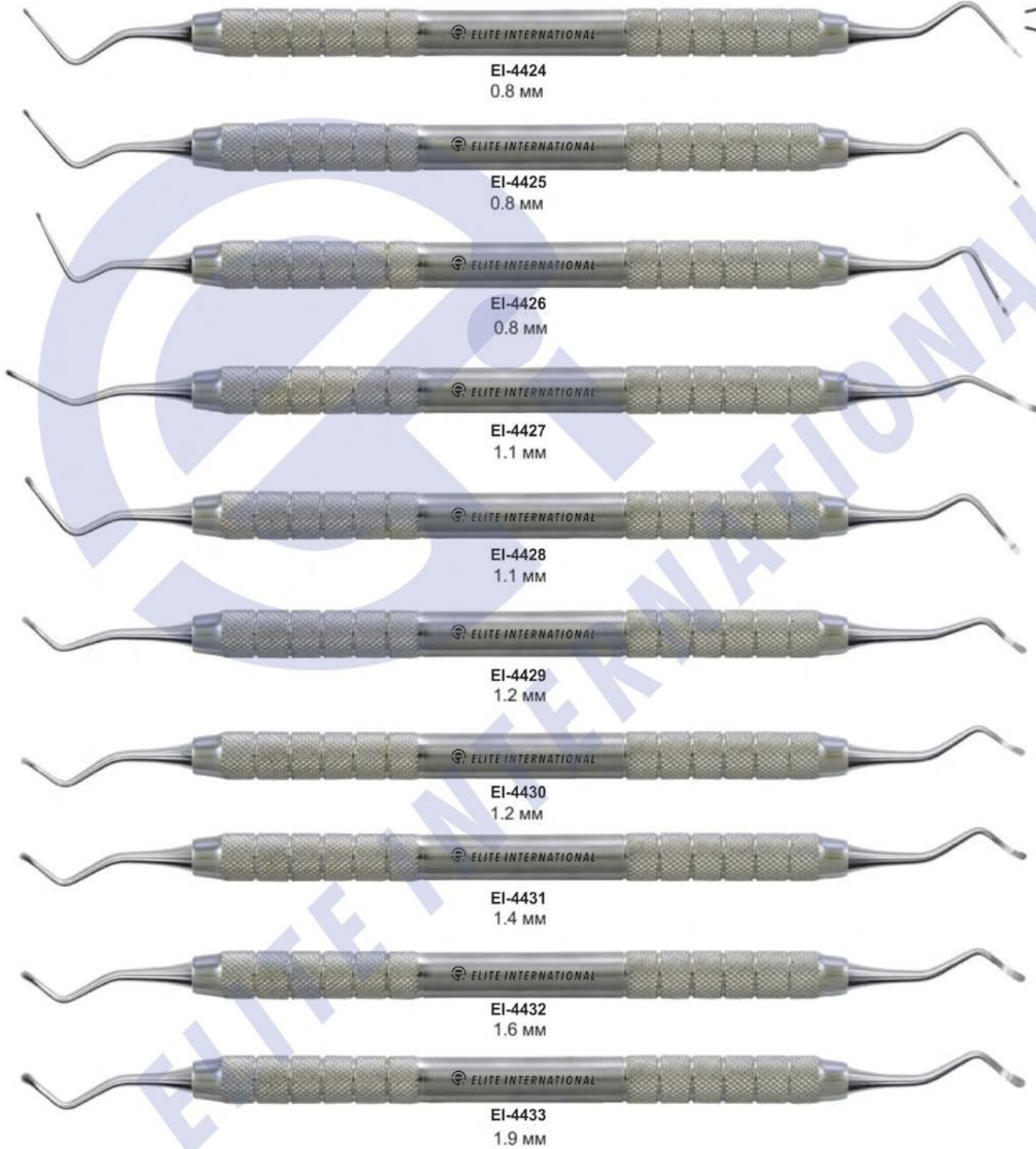



COMPOSITE BALL PLUGGERS

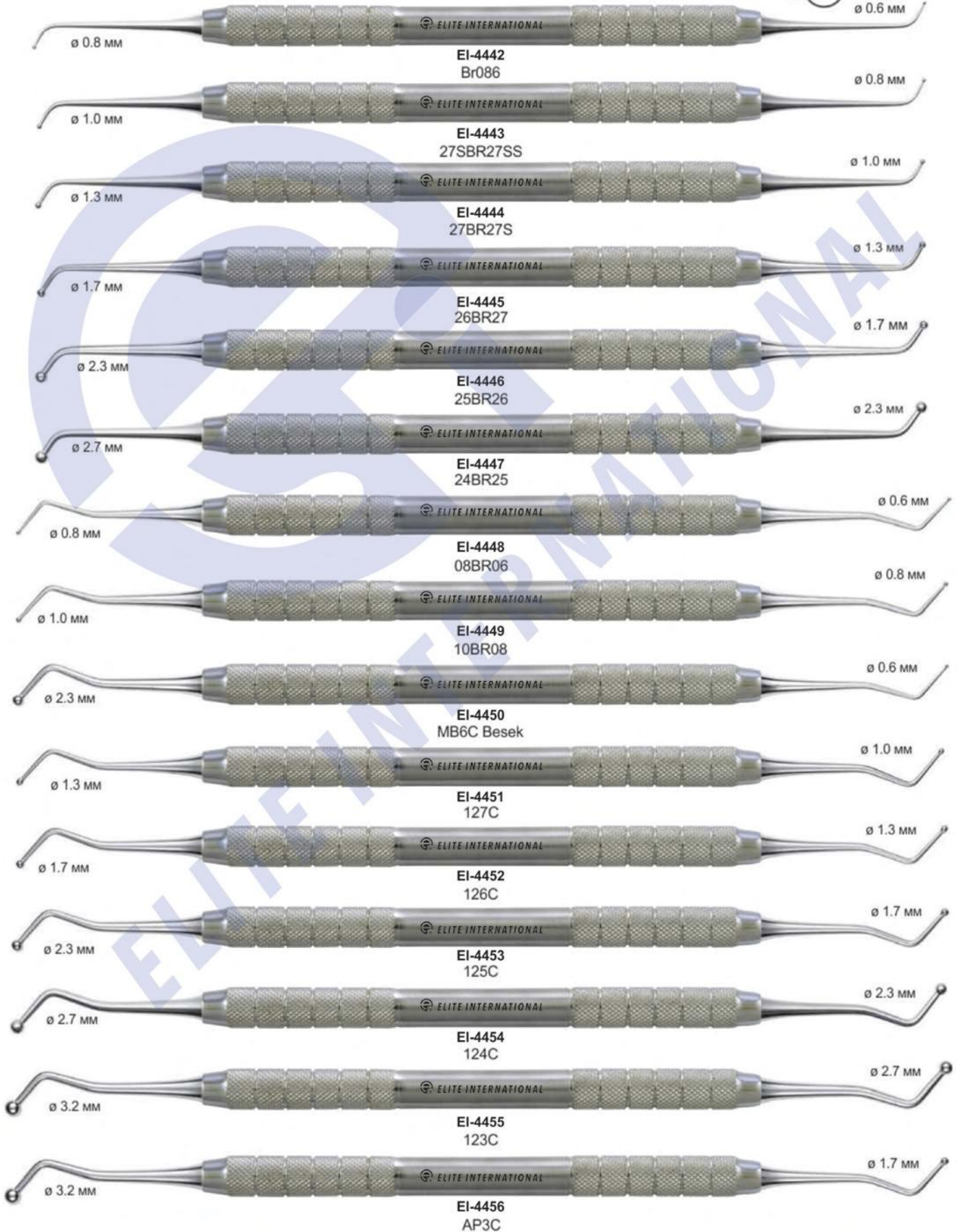

FILLING INSTRUMENTS CONSERVATIVE TREATMENT

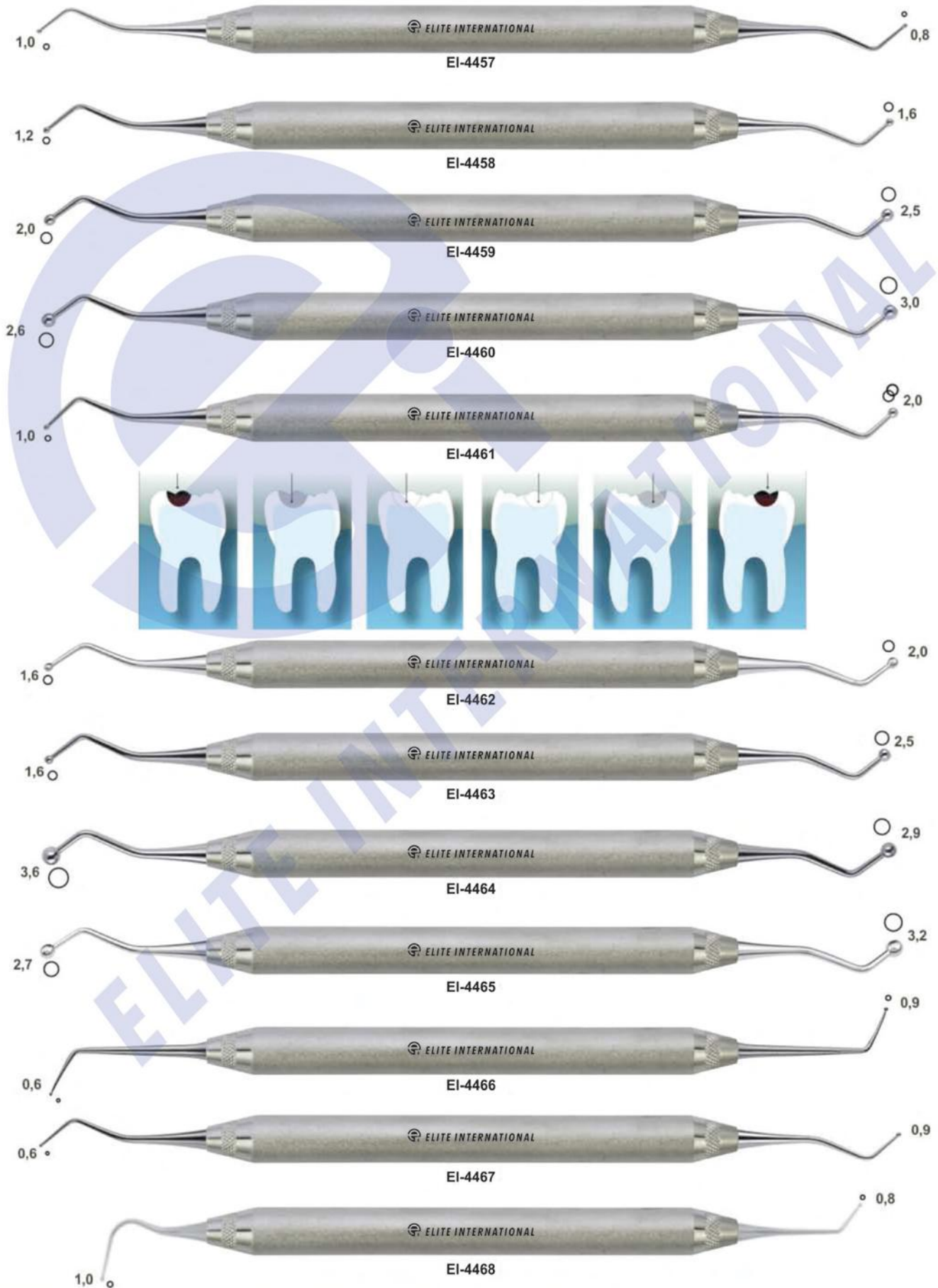

FILLING INSTRUMENTS CONSERVATIVE TREATMENT



FILLING INSTRUMENTS CONSERVATIVE TREATMENT

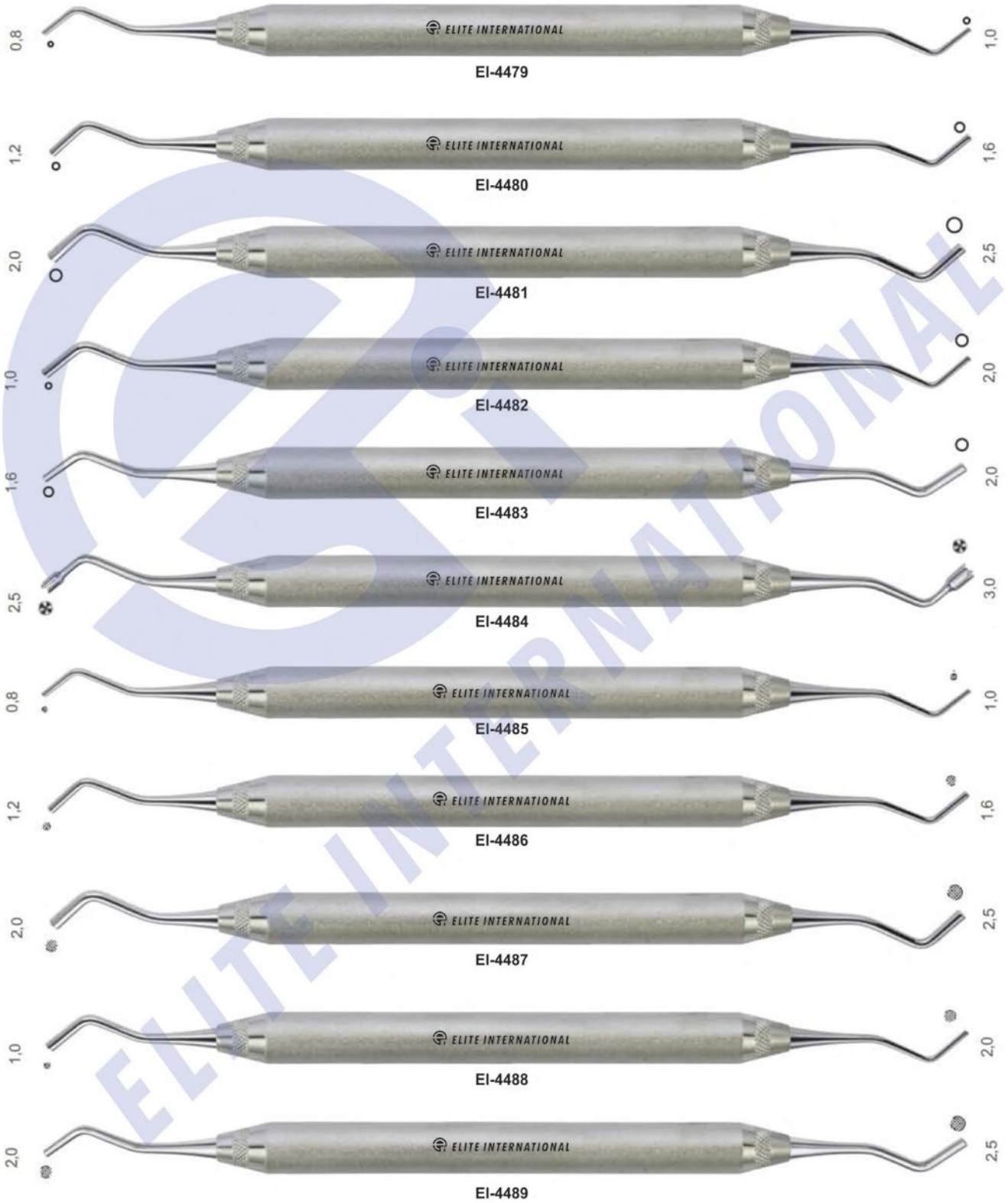

FILLING INSTRUMENTS CONSERVATIVE TREATMENT

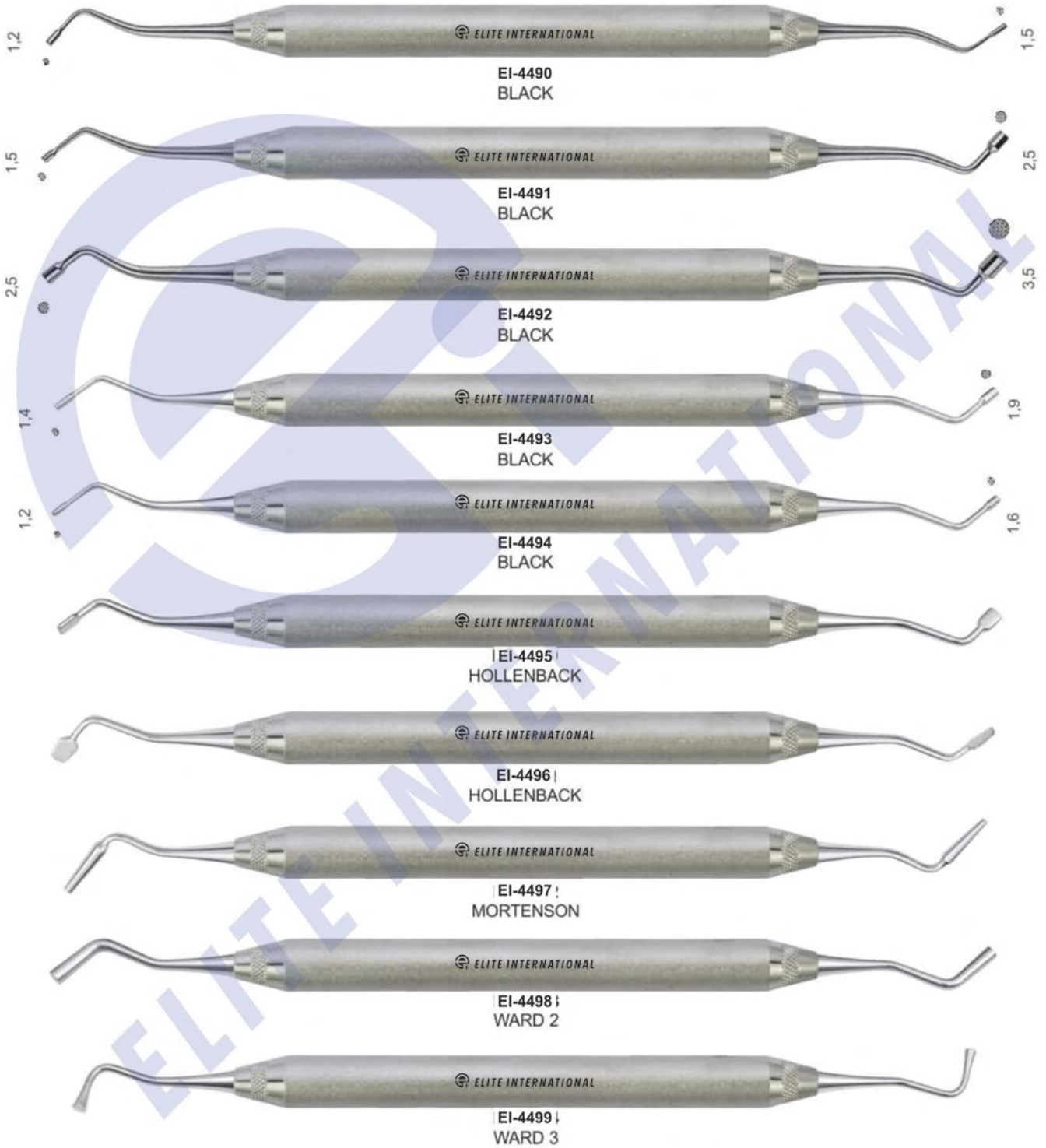

FILLING INSTRUMENTS CONSERVATIVE TREATMENT



EI-4500
WILLIAMS



EI-4501
WILLIAMS



EI-4502
WILLIAMS



EI-4503



EI-4504



EI-4505



EI-4506



EI-4507



EI-4508



EI-4509

COMPOSITE PLUGGERS INSTRUMENTS

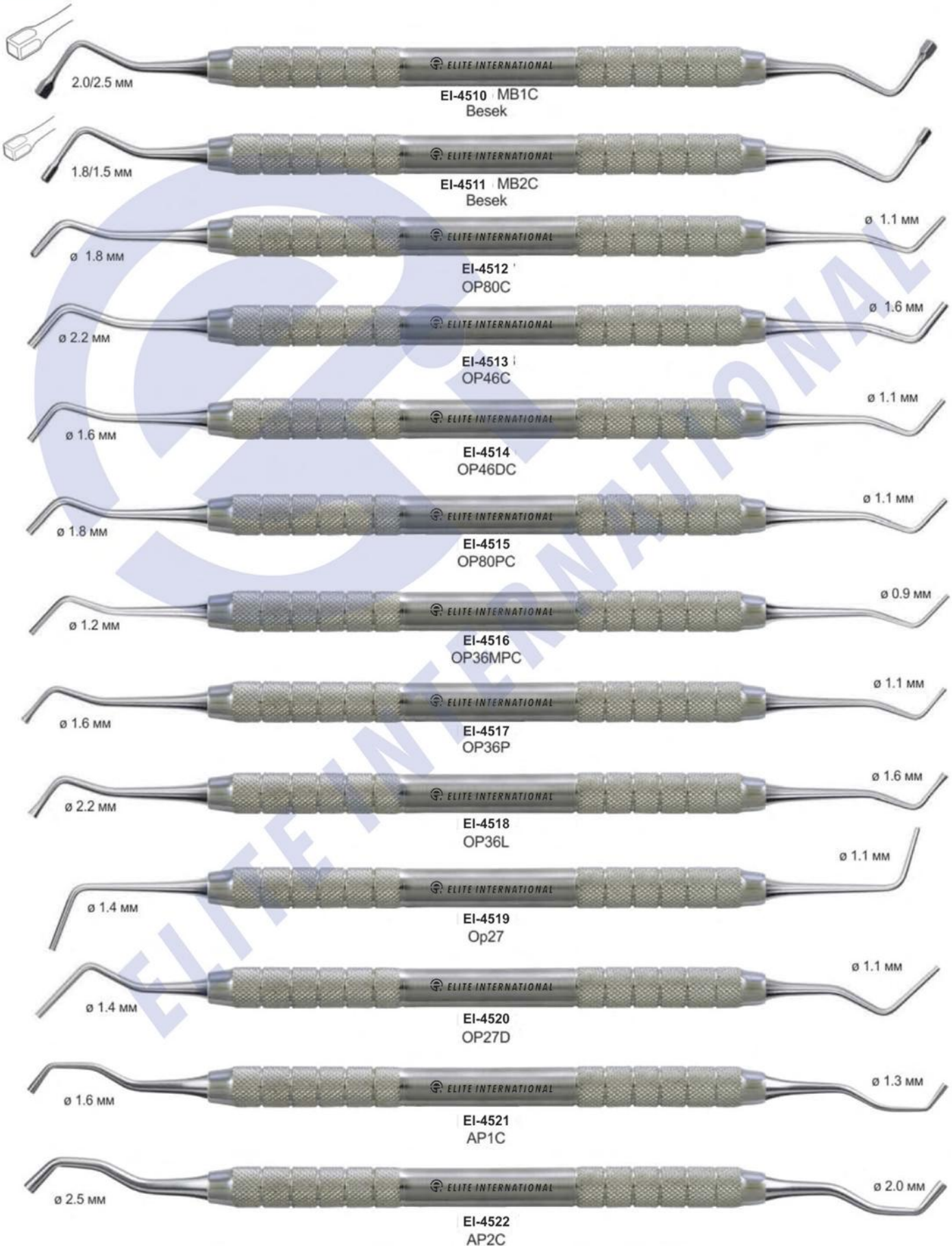





COMPOSITE PLUGGERS INSTRUMENTS



Serrated Pluggers



Ø 0.9 MM		Ø 1.2 MM
	EI-4529 OP36M	
Ø 1.1 MM		Ø 1.6 MM
	EI-4530 OP36D	
Ø 1.6 MM		Ø 2.2 MM
	EI-4531 Op36	
Ø 1.0 MM		Ø 1.7 MM
	EI-4532 Op52	
Ø 2.2 MM		Ø 2.6 MM
	EI-4533 Zi51	
Ø 1.8 MM		Ø 2.2 MM
	EI-4534 Op44	
Ø 1.7 MM		Ø 2.6 MM
	EI-4535 1BR2	
Ø 2.6 MM		Ø 3.6 MM
	EI-4536 2BR3	



COMPOSITE MODELLING INSTRUMENTS



EI-4537 MF2C
Fuzzi



EI-4538
Pj4



EI-4539 MB3C
Besek



EI-4540
HZ3C



EI-4541
CPRO3C



EI-4542 Mo1
Monari



EI-4543 TH28C
Hirt



EI-4544
HZ25C



EI-4545
Ck10



EI-4546
CK28BC



EI-4547 Op37
Carver



EI-4548
28BR29

EXCAVATORS

Round excavators

Cariology

- for the removal of softened, carious dentin
- for the removal of temporary fillings

Surgery

- to sever the periodontal ligament prior to extraction
- for the removal of granulation tissue after extraction

Design: Round working end Curved cutting edge



Round Excavator, 1.0 mm
EI-4549



Round Excavator, 1.5 mm
EI-4550



Round Excavator, 2.0 mm
EI-4551

Triple-angled back action excavators



Triple-angled Back Action Excavator, 1.0 mm
EI-4552



Triple-angled Back Action Excavator, 1.5 mm
EI-4553



Triple-angled Back Action Excavator, 2.0 mm
EI-4554



Triple-angled Back Action Excavator, 3.5 mm
EI-4555



FILLING INSTRUMENTS

- Инструменты для реставрации
- Instruments pour plombage
- Füllungsinstrumente (mit Kontrawinkel)
- Инструменти для реставрації
- Instrumentos para obturaciones
- ملء الصكوك

COMPOSITE/PLASTIC FILLING INSTRUMENTS SOLID HANDLE 6MM, LENGTH 170MM

BLACK

PLUGGERS/CONDENSERS

Hollenback

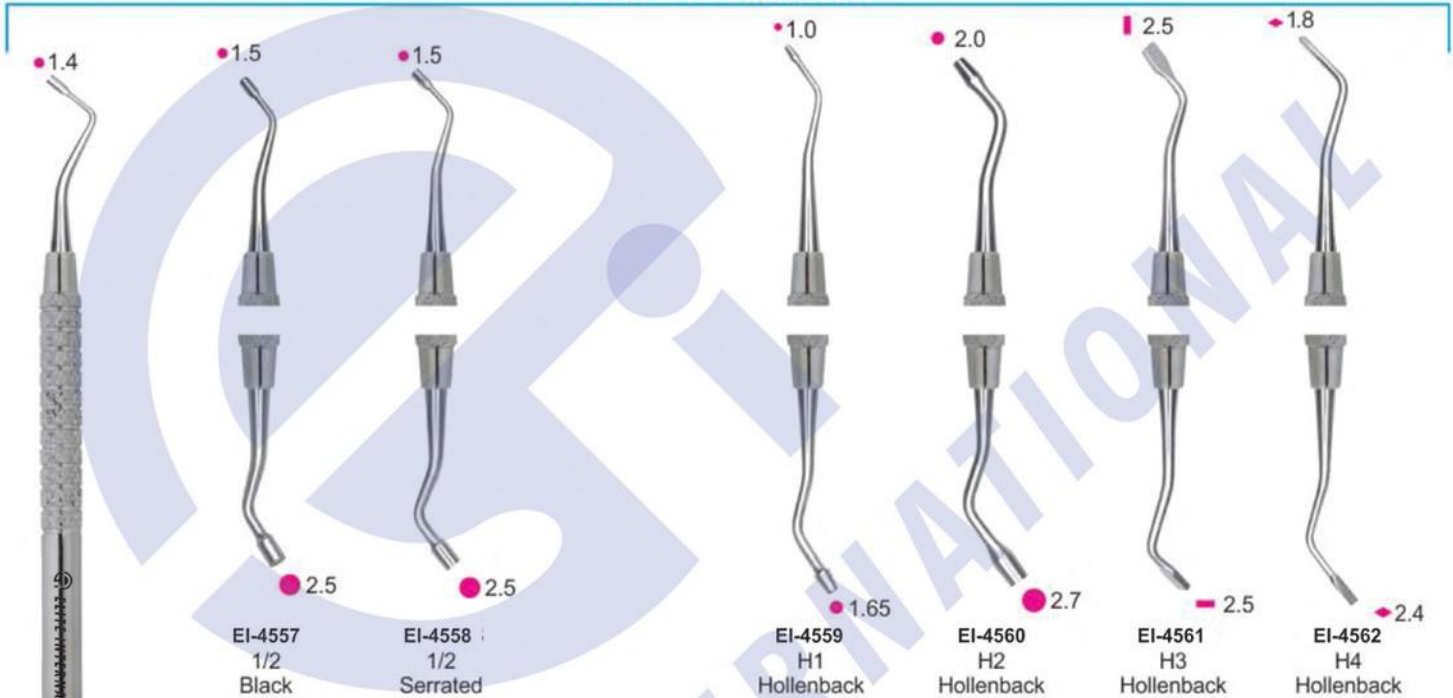

MARQUETTE CONDENSER

MORTONSON

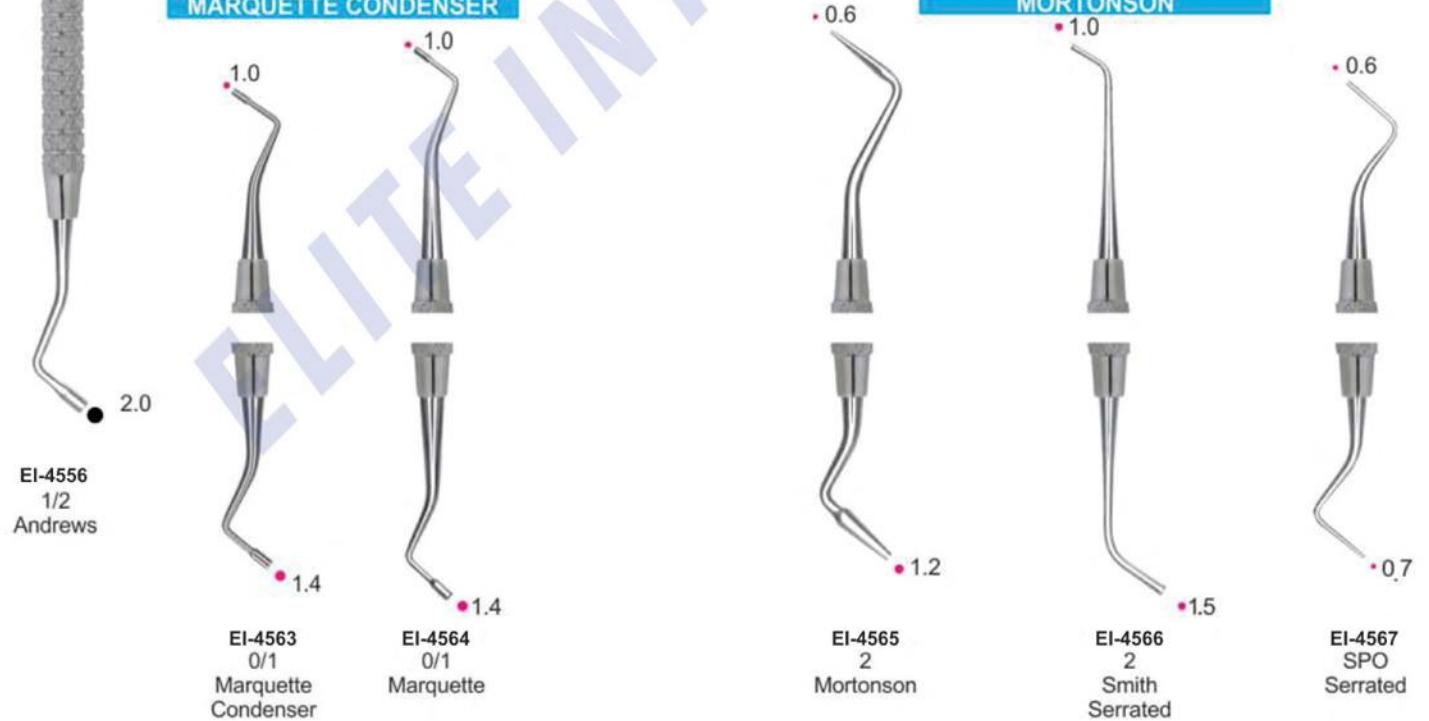

FILLING INSTRUMENTS

- Инструменты для реставрации
- Instruments pour plombage
- Füllungsinstrumente (mit Kontrawinkel)
- Инструменти для реставрації
- Instrumentos para obturaciones
- ملء الصكوك

RESTORATIVE INSTRUMENTS SOLID HANDLE 6MM, LENGTH 170MM Back Action Filling Instruments

Tanner Filling Instruments

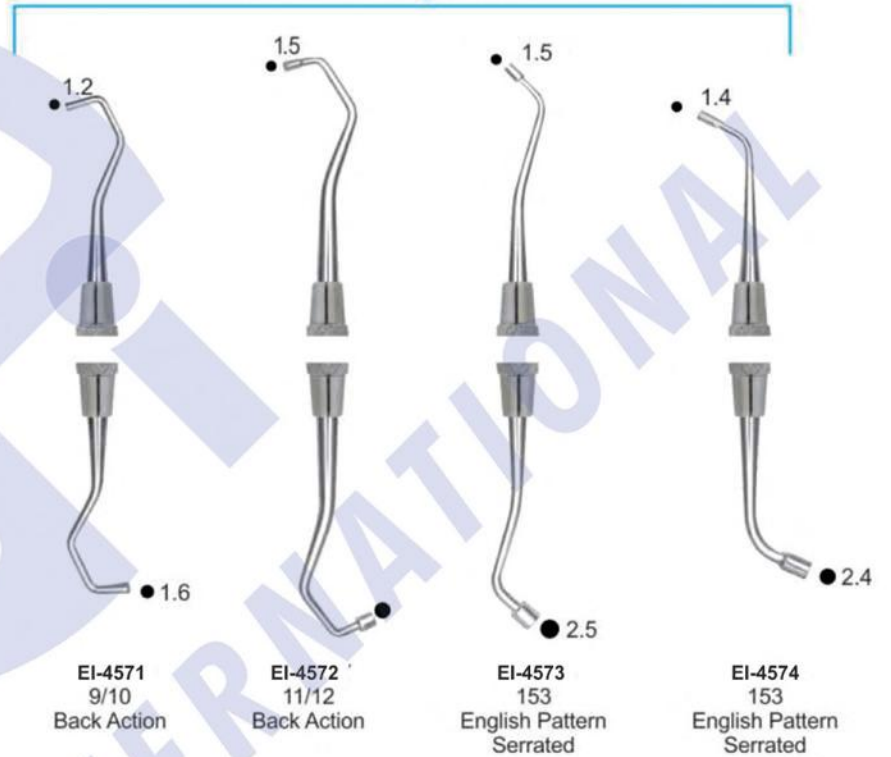
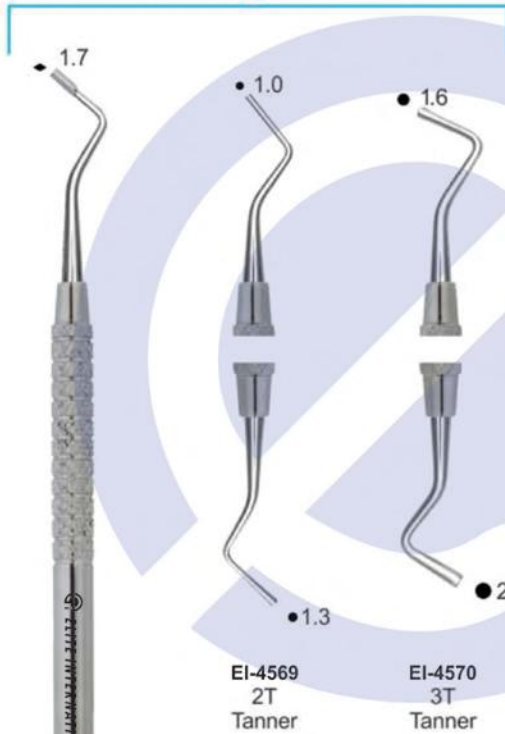

BALL



BURNISHERS



BEAVERTAIL



ACORN



LADMORE



CARVERS INSTRUMENTS

- Инструменты для реставрации
- Instruments a modeler
- Modellierinstrumente
- Инструменти для реставрації
- Instrumentos para modelar
- أدوات تقطيع

P.K. THOMS WAXING INSTRUMENTS SOLID HANDLE 6mm

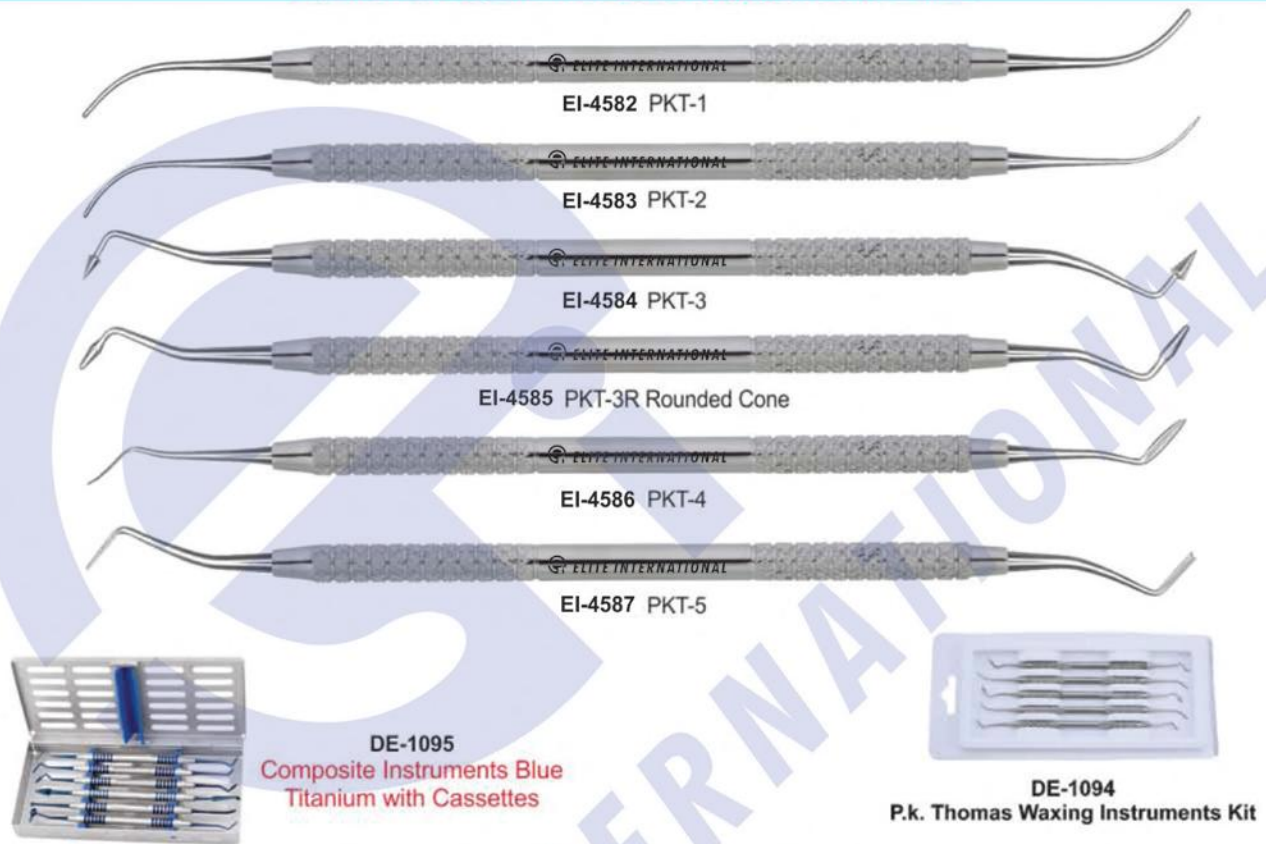

COMPOSITE INSTRUMENTS TITANIUM BLUE ENDODONTIC

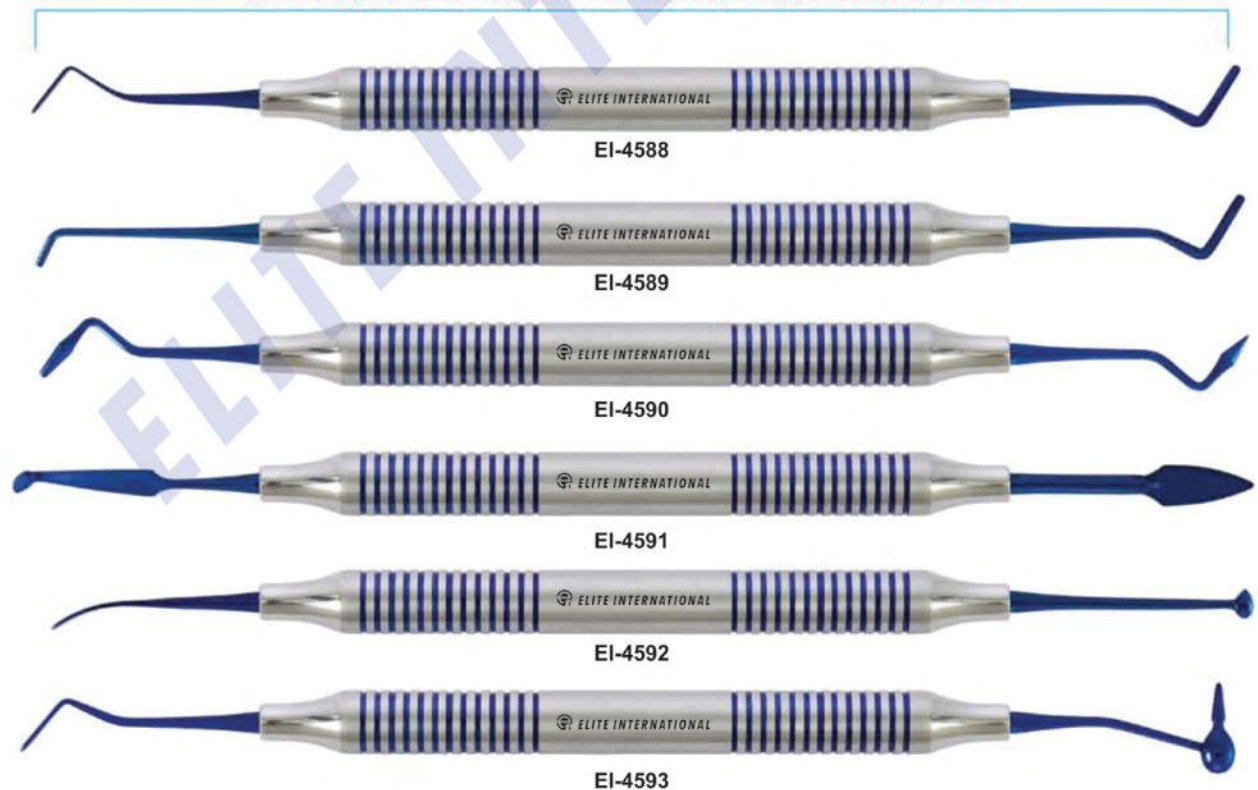

CARVERS INSTRUMENTS

- Инструменты для реставрации
- Instruments a modeler
- Modellierinstrumente
- Инструменти для реставрації
- Instrumentos para modelar
- أدوات تقطيع



EI-4594



EI-4595



EI-4596



EI-4597



EI-4598



Cassette For 5 Instruments
EI-4599

FILLING INSTRUMENTS

- Инструменты для реставрации
- Instruments pour plombage
- Füllungsinstrumente (mit Kontrawinkel)
- Инструменти для реставрації
- Instrumentos para obturaciones
- ملء الصكوك

FILLING INSTRUMENTS (Gold Pointed) SOLID HANDLE 6MM, LENGTH 170MM



EI-4600 1.5mm / 1.5mm

EI-4601 2.0mm / 2.0mm

EI-4602 2.0mm / 2.0mm

EI-4603 2.5mm / 2.5mm

EI-4604 1.3mm / 0.9mm

EI-4605 1.6mm / 1.3mm

EI-4606 2.4mm / 1.8mm

EI-4607 2.4mm / 2.0mm

EI-4608 1.3mm / 1.5mm

EI-4609 1.8mm / 1.2mm

Filling instrument,
spatula 6 mm solid handle,
length 170 mm,

Filling instrument
6 mm
length 175 mm,

Filling instrument,
ball 6 mm
length 170 mm,

Filling instrument,
ball / spatula
6 mm
length 175 mm,

Filling instrument,
plan / plan 6 mm
length 165 mm,

COMPOSITE FILLING INSTRUMENTS

- Инструменты для реставрации
- Instruments pour plombage
- Füllungsinstrumente (mit Kontrawinkel)
- Інструменти для реставрації
- Instrumentos para obturaciones
- ملء الصكوك

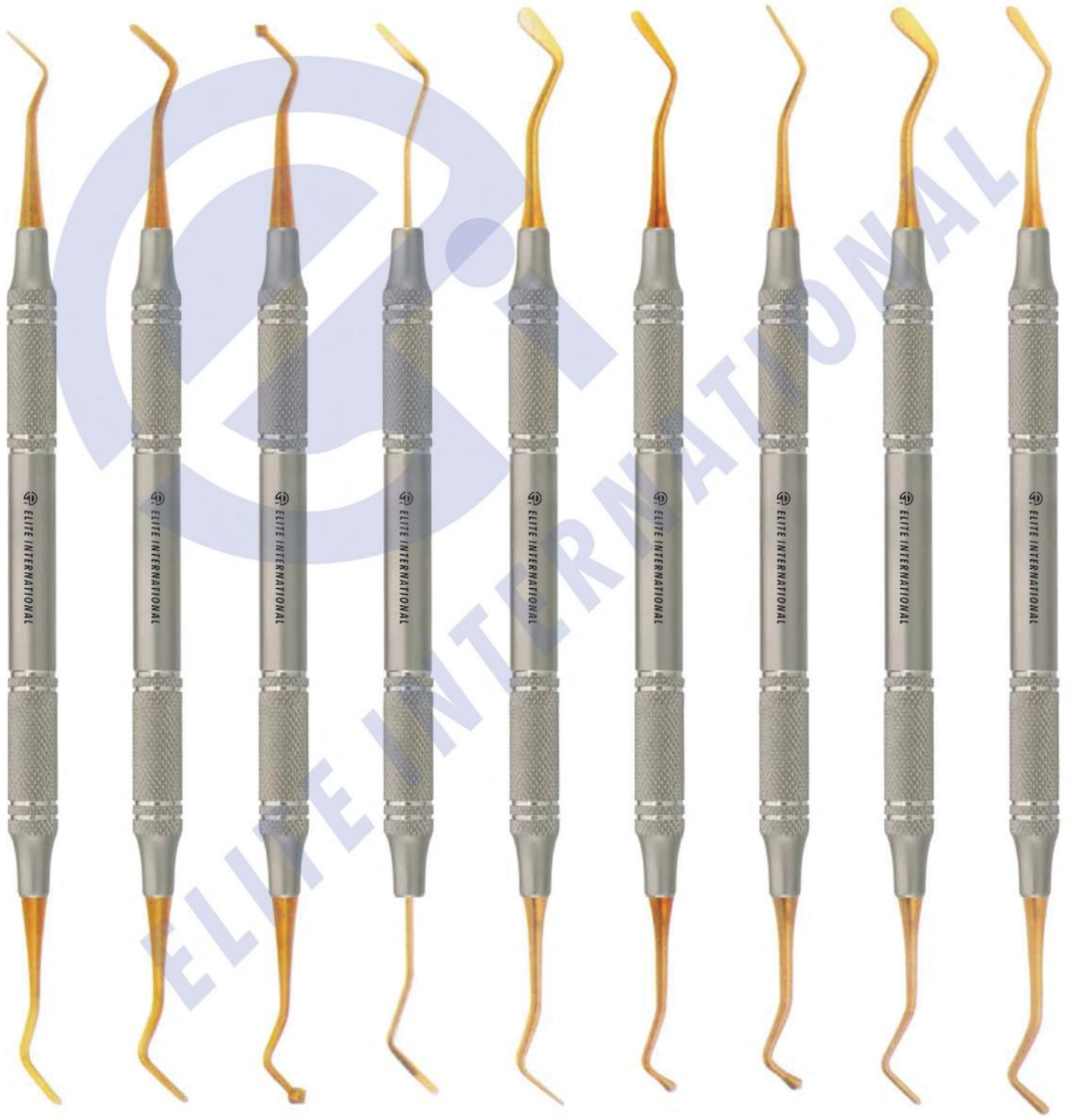

EI-4610

EI-4611

EI-4612

EI-4613

EI-4614

EI-4615

EI-4616

EI-4617

EI-4618

COMPOSITE FILLING INSTRUMENTS

- Инструменты для реставрации
- Instruments pour plombage
- Füllungsinstrumente (mit Kontrawinkel)
- Інструменти для реставрації
- Instrumentos para obturaciones
- ملء الصكوك

Composite Gold Tip Instruments



MISCELLANEOUS PRODUCTS

- Прочие товары
 - Divers produits et services
 - Sonstige Produkte
- Інші товари
 - Varios Productos
 - المنتجات المتنوعة



EI-4630
X Ray Film Hangers



EI-4631
X Ray Film Hangers



EI-4632
X Ray Film Hangers



EI-4633
X Ray Film Hangers



EI-4634
X Ray Film Hangers



EI-4635
X Ray Film Hangers



EI-4636
X Ray Film Hangers



EI-4637



EI-4638



EI-4639



Dissecting Set
EI-4640 Set of 9 Pcs.
EI-4641 Set of 11 Pcs.



DE-1150
Napkin Holder with Plastic Chain

EI-4642
Napkin holder with metal chain



Mouth Props
EI-4643
Small

Mouth Props
EI-4644
Medium

Mouth Props
EI-4645
Large

Key Rings



EI-4646



EI-4647



EI-4648



EI-4649



EI-4650



EI-4650

CEMENT SPATULAS

- Шпатели для цемента
- Spatules à ciment
- Zementspatel
- Шпатели для цементу
- Espátulas para cemento
- ملاعق الاسمنت



WAX KNIVES

- Ножи для воска
 - Couteaux a cire
 - Wachsmesser
- Ножи для воску
 - Cuchillos para cera
 - السكاكين الشمع

ALGINATE, PLASTER SPATULAS, WAX KNIVES PLASTER FOR KNIVES & PLASTER SHEAR



EI-4673
Wooden Handle
Fig. 5
21.5 cm



EI-4674
Wooden Handle
Fig. 7
19.5 cm curved



EI-4675
Wooden Handle
Fig. 8
20 cm curved



EI-4676
Wooden Handle
Fig. 9
22.5 cm curved



EI-4677
Hook Knives



EI-4678
Fig. 1
Lessmann
12.5 cm



EI-4679
Fig. 2
Lessmann
17 cm



EI-4680
Fig. 1
with small spoon
12.5 cm



EI-4681
Fig. 2
with large spoon
17 cm



EI-4682
Bacolite Handle
Wax Knives,
Small



EI-4683
Bacolite Handle
Wax Knives,
Large



EI-4684
Wooden Handle
Wax Knives,
Small



EI-4685
Wooden Handle
Wax Knives,
Large



EI-4686
Plaster Knife



EI-4687
Fig. 1
17 cm



EI-4688
Fig. 3
16 cm



EI-4689
Fig. 4
16 cm



EI-4690
Special Inox
19.5 cm

ARTICULATORS

- Артикуляторы
 - Artocilar
 - Artikulations
- Артикулятори
 - Articuler
 - ارتیکولاتورس



EI-4691

Technical Datas:

Intercondylar distance 120 mm.
 condylar inclination fixed at 30°
 Bennet angle fixed at 7°
 Incisal table inclination 10°
 Distance between mounting plates 85 mm.
 Weight 400 gr.
 Opening (item 5000) 125°
 Opening (item 5010) 180°



EI-4692

Technical Datas:

Intercondylar distance 110 mm.
 condylar inclination fixed at 30°
 Bennet angle fixed at 7°
 Incisal table inclination flat
 Distance between mounting plates 85 mm.
 Weight 450 gr.
 Opening 180°



EI-4693

Stainless Steel Finishing
 EI-4694
 Royal Blue



EI-4695



EI-4696



EI-4697'



EI-4698



EI-4699



EI-4700



EI-4701



EI-4702



EI-4703



EI-4704
 Nakawalni
 Dental Laboratory
 Instrument

DENTAL PHOTOGRAPHIC MIRRORS

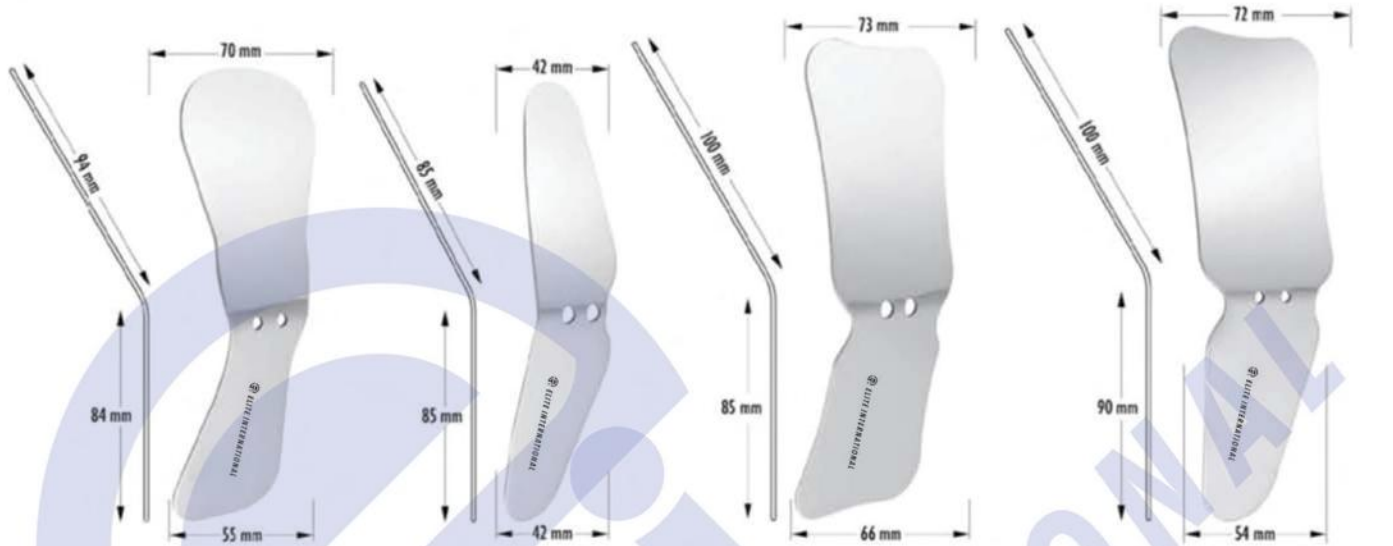

EI-4705 Adult Palatal /
EI-4706 Child Palatal

EI-4707
Buccal

EI-4708 Adult Palatal /
EI-4709 Child Palatal

EI-4710 Adult Palatal /
EI-4711 Adult Buccal

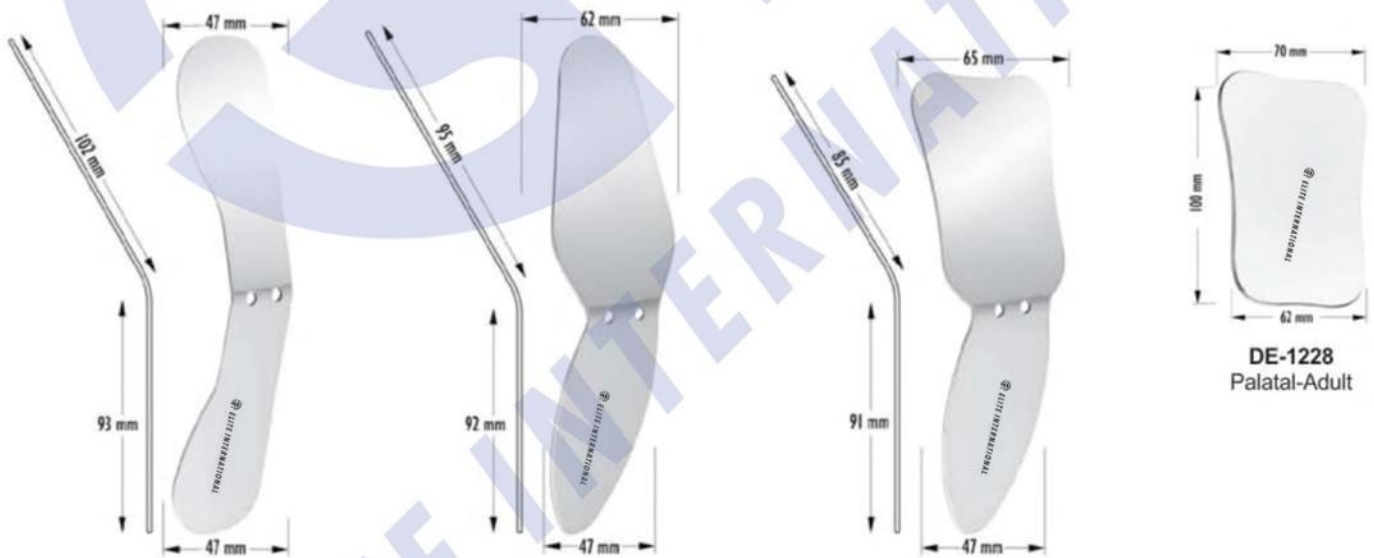

EI-4712 Lingual upper /
EI-4713 Lingual Lower

EI-4714 Adult Buccal /
EI-4715 Child Buccal

EI-4716 Child Palatal /
EI-4717 Child Buccal

DE-1228
Palatal-Adult

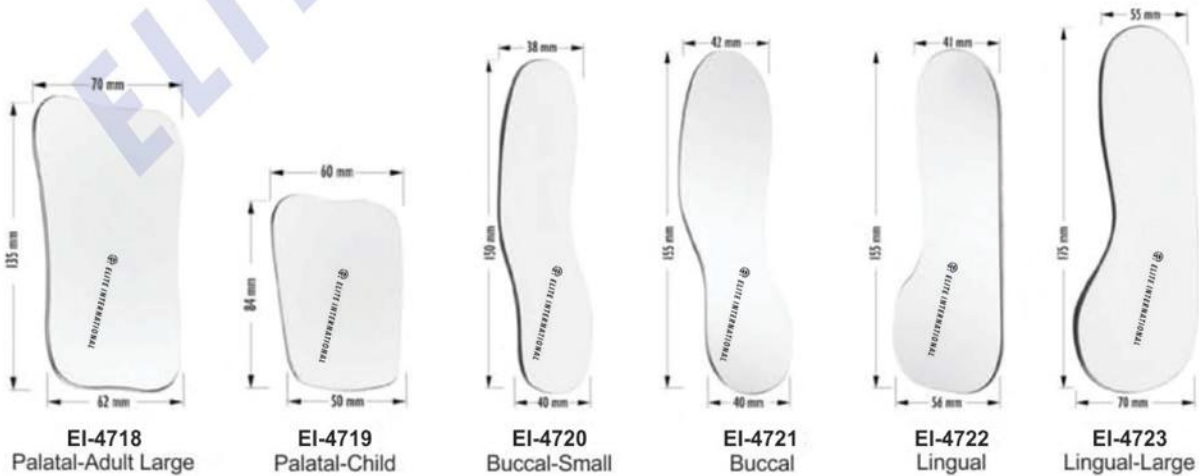

EI-4718
Palatal-Adult Large

EI-4719
Palatal-Child

EI-4720
Buccal-Small

EI-4721
Buccal

EI-4722
Lingual

EI-4723
Lingual-Large

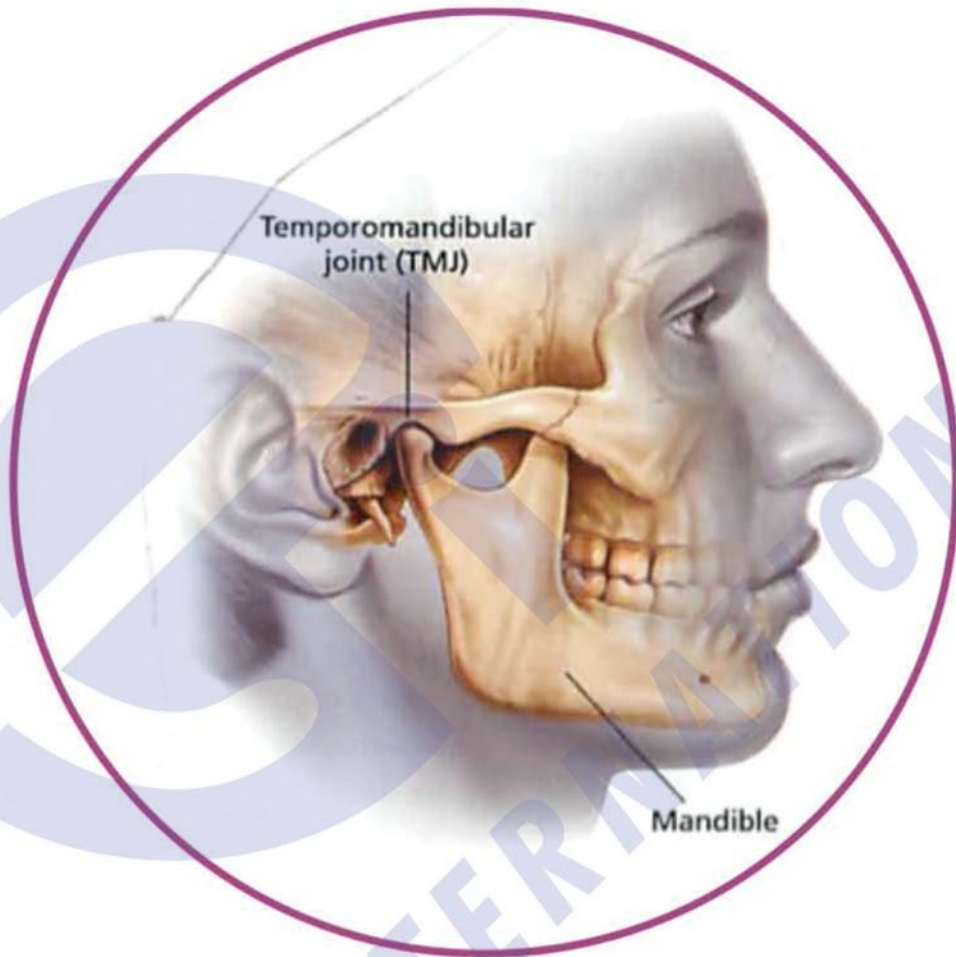

RETRACTORS - MOUTH GAGS

- Роторасширители
- Ecarteurs - Ouvre-bouches
- Vestibulumabhalter / Mundspanner
- Роторозширювачі
- Separadores - Abre-bocas
- الكاشطات، الكمامات الفم



EI-4724
HMG
Heister
130mm



EI-4725
Mouth Gag Molt
11 cm for (Children)



EI-4726
Mouth Gag Molt
14 cm for (Adults)



Sternberg Retractors
EI-4727 140 mm
EI-4728 180 mm



Columbia Retractor
EI-4729 140 mm



EI-4730
Wangen Holder
vestibule
15 cm, with or without
lip protection,



EI-4731
Wangen Holder
vestibule 15 cm, with
or without lip protection



EI-4732
Wangen Holder
with dual
function, 17 cm



Weider Retractor



EI-4733
140 mm



EI-4734
150 mm

RETRACTORS - MOUTH GAGS

- Роторасширители
- Ecarteurs - Ouvre-bouches
- Vestibulumabhalter / Mundspanner
- Роторозширювачі
- Separadores - Abre-bocas
- الكاشطات - الكمامات الفم



Weitlaner
Fig. 1
EI-4735 10.5cm
EI-4736 13.5cm



Weitlaner
Fig. 2
EI-4737 10.5cm
EI-4738 13.5cm



EI-4739
Lip & Cheek Retractor
Stainless Steel
Double Ended



EI-4740
Simplex Retractor
Stainless Steel
Single Ended



Weitlander
EI-4741 11cm
EI-4742 13cm
EI-4743 15cm



EI-4747
Denhard
12 cm



EI-4748
Roser-König
16 cm



EI-4749
Roser-König
19 cm



Jennings
EI-4744 11cm
EI-4745 13cm
EI-4746 15cm

RETRACTORS

- Ранорасширители
- Ecarteurs
- Wundhaken
- Ранорозширювачі
- Separadores
- الكاشحات

Wound, Bendable
Retractor, individually or as saving kit!



EI-4750
Cheek Retainer
One-sided
Long



EI-4751
Cheek Retainer
One-sided
Long



EI-4752
Cheek Retainer
One-sided
Long



**Ergo Grip
Retractor**
EI-4753 24 cm
ergonomic handle,



Ivory Retractors
Width adjustable
& fixable,
EI-4754 20 cm



Bruenings Retractors
tongue depressors
EI-4755 19 cm



**Minnesota
Retractors**
EI-4756 16 cm



Ribbon Retractors
EI-4757 20 cm
easy to bend
by hand,



Bishop Retractors
retractor and tongue
pushers Bishop with
comfortable margin
EI-4758 16 cm



**Combination
Retractors**
EI-4759 25 cm

RETRACTORS

- Ранорасширители
 - Ecarteurs
 - Wundhaken
- Ранорозширювачі
 - Separadores
 - الكاشطات



EI-4760
Unique Retractors
Length 175 mm
angled 45°



EI-4761
Unique Retractors
Length 175 mm
angled 90°



EI-4762
Retractors
16cm



EI-4763
Retractors
19cm



EI-4764
Mini-Langenbeck
Retractors
16 cm, hooks 22 mm



EI-4765
US army Retractors
21 cm, 2



EI-4766
ALM Retractor
about 8 cm



EI-4767
Senn Mueller Retractor
17 cm, hooks 22 mm

RETRACTORS

- Ранорасширители
- Ecarteurs
- Wundhaken
- Ранорозширювачі
- Separadores
- الكاشحات



EI-4768
Langenbeck Retractors
surgical-flat
21 cm, hook
30x16 mm



EI-4769
Langenbeck Retractors
surgical-flat
21 cm, hook
42x11 mm



EI-4770
Langenbeck Retractors
surgical-flat
21 cm, hook
63x12 mm



Langenbeck Retractors
surgical-flat
21 cm, hook
EI-4771 30x16 mm
EI-4772 42x11 mm
EI-4773 63x12 mm



Langenbeck Retractors
21 cm, hook
EI-4774 30x11 mm
EI-4775 30x16 mm



EI-4776
Middelborpf
Retractors
21 cm

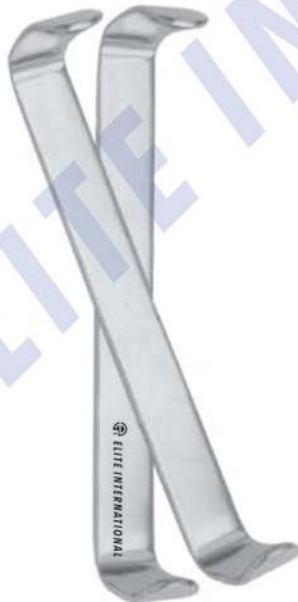

EI-4777
Farabeuf
(120 X 12mm
Set of 2 pices)



EI-4778
Retractor Seldin



EI-4779
Feldman Retractor
14cm

GUM SCISSORS

- Ножницы десневые
- Ciseaux a gencives
- Zahnfleischscheren

- Ножци для ясен
- Tijeras para encias
- مقص صمغ



EI-4780
Iris
115mm
Straight

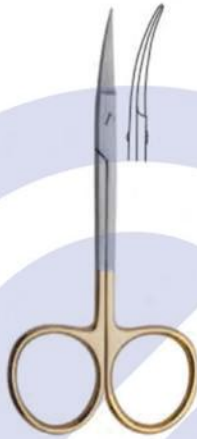

EI-4781
Iris
115mm
Curved



EI-4782
Goldman-Fox
130mm
Saw edge, straight



EI-4783
Goldman-Fox
130mm
Saw edge, Curved



EI-4784
La Grange
115mm
Saw edge, double Curved



Mayo
EI-4785 140mm
EI-4786 170mm
EI-4787 230mm
Straight



Mayo
EI-4788 140mm
EI-4789 170mm
EI-4790 230mm
Curved



Metzenbaum
EI-4791 145mm
EI-4792 180mm
EI-4793 200mm
Straight



Metzenbaum
EI-4794 145mm
EI-4795 180mm
EI-4796 200mm
Curved



EI-4797
Kelly
160mm
Straight



EI-4798
Kelly
160mm
Curved



EI-4799
Iris
115mm
Straight



EI-4800
Iris
115mm
Curved



EI-4801
La Grange
115mm
Double Curved



EI-4802
Goldman-Fox
130mm, Straight



EI-4803
Goldman-Fox
130mm, Curved



EI-4804
Kelly
160mm, Curved



EI-4805
Iris
115mm, Straight



EI-4806
Iris
115mm, Curved



EI-4807
Micro Iris
90mm, Curved

GUM SCISSORS

- Ножницы десневые
- Ciseaux a gencives
- Zahnfleissscheren
- Ножиці для ясен
- Tijeras para encias
- مقص صمغ



EI-4808
Iris
115mm
Angled



EI-4809
Iris
115mm
Curved



EI-4810
Goldman-Fox
130mm
Saw edge,
straight



EI-4811
Goldman-Fox
130mm
Saw edge,
curved



EI-4812
Goldman-Fox
130mm
Saw edge,
double curved



EI-4813
La Grange
115mm
Saw edge,
double curved



EI-4814
Neumann
120mm
Saw edge,
double curved



EI-4815
Kilner (Ragnell)
120mm
Straight



EI-4816
Kilner (Ragnell)
120mm
Curved



EI-4817
Joseph
140mm
Straight



EI-4818
Joseph
140mm
Curved



EI-4819
Kelly
160mm
Straight



EI-4820
Kelly
160mm
Curved



EI-4821
Locklin
160mm
Saw edge,
angular



EI-4822
Locklin
120mm
EI-4823
160mm
Saw edge, angular



EI-4824
Dean
170mm
Saw edge,
angular

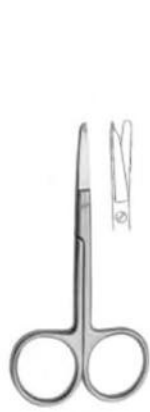

EI-4825
Spencer
90mm



EI-4826
Spencer
130mm



EI-4827
Spencer
115mm



EI-4828
Noyes
110mm, Straight



EI-4829
Noyes
110mm
Curved



EI-4830
Noyes
110mm
Angular



EI-4831
Castroviejo
150mm
Curved

GUM SCISSORS

NEEDLE HOLDERS

- Ножницы десневые
- Ciseaux a gencives
- Zahnfleischscheren

- Ножици для ясен
- Tijeras para encias
- مقص صمغ

- Иглодержатели
- Porte-aiguilles
- Nadelhalter

- Голкотримачи
- Porta-agujas
- اصحاب ابرة



EI-4832
130mm
Straight



EI-4833 Mayo Mayo
130mm 130mm
EI-4834 160mm 160mm
EI-4835 180mm 180mm
Straight Curved



EI-4836 Mayo Mayo
140mm 140mm
EI-4837 200mm 200mm
Straight Curved



EI-4838 Metzenbaum
145mm 145mm
EI-4839 200mm 200mm
Straight Curved



EI-4840
Beebee
110mm
Saw edge,
straight



EI-4841
Beebee
110mm
Saw edge,
curved



EI-4842
Beebe
110mm
Saw edge, straight



EI-4843
Beebe
110mm
Saw edge, curved

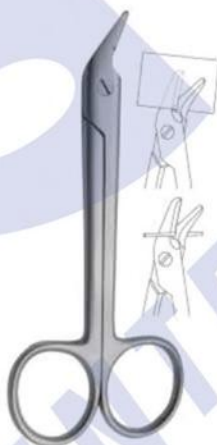

EI-4844
Universal
120mm
Saw edge



EI-4845
Universal
120mm



Ryder
EI-4846 130mm
EI-4847 150mm
EI-4848 180mm



EI-4849
Halsey
130mm



EI-4850
Baumgartner
130mm



EI-4851
Derf
120mm



EI-4852
Delicate
150mm



Mayo-Hegar
EI-4853 130mm
EI-4854 160mm
EI-4855 180mm
EI-4856 200mm



EI-4857
Crile-Wood
150mm
straight



EI-4858
Crile-Wood
150mm
curved

NEEDLE HOLDERS

- Иглодержатели
- Porte-aiguilles
- Nadelhalter

- Голкотримачи
- Porta-agujas
- اصحاب إبرة



Ryder
EI-4859 130mm
EI-4860 150mm
EI-4861 180mm



EI-4862
Halsey
130mm



EI-4863
Baumgartner
130mm



EI-4864
Derf
120mm



EI-4865
Delicate
150mm



EI-4866
Adson
170mm



Mayo-Hegar
EI-4867 130mm
EI-4868 160mm
EI-4869 180mm
EI-4870 200mm



EI-4871
Crile-Wood
150mm



Castroviejo
EI-4872 str 140mm cvd
EI-4873 str 180mm cvd



Olsen-Hegar Needle
Holder With Scissors
EI-4874 140mm



Gillies Needle
Holder With Scissors
EI-4875 160mm



Mathieu
EI-4876 140mm
EI-4877 170mm



Castroviejo
EI-4878 str 140mm cvd
EI-4879 str 180mm cvd



Olsen-Hegar Needle
Holder With Scissors
EI-4880 140mm



Gillies Needle
Holder With Scissors
EI-4881 160mm

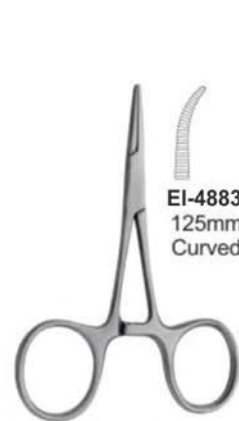

EI-4883
125mm
Curved
Hartmann (Baby
Mosquito)
EI-4882 90mm straight



EI-4885
Curved
Halstead Mosquito
EI-4884 125mm
Straight

GUM SCISSORS

- Ножницы десневые
- Ciseaux a gencives
- Zahnfleischscheren
- Ножці для ясен
- Tijeras para encias
- مقص صمغ



EI-4886
Goldman Fox Scissors
12.5cm Curved



EI-4887
Iris Scissors
11.5cm Curved
Serrated For Slip-Free Cutting



EI-4888
LaGrange Scissors
11.5cm Double Curved
Serrated For Slip-Free Cutting

Double
Curved



EI-4889
Castroviejo Micro Scissors
12cm Curved



EI-4890
Super Cut Goldman Fox
13.2cm Curved
Serrated For Slip-Free Cutting



EI-4891
Super Cut Iris
11cm Straight
Serrated For Slip-Free Cutting



EI-4892
Super Cut LaGrange
11cm Curved
Serrated For Slip-Free Cutting



EI-4893
Super Cut LaGrange
11.5cm
Double Curved
Serrated For Slip-Free Cutting

Double
Curved

NEEDLE HOLDERS

- Иглодержатели
 - Porte-aiguilles
 - Nadelhalter
- Голкотримачи
 - Porta-agujas
 - اصحاب ابرة



EI-4894
Lichtenberg-
Ryder T.C
14 cm



EI-4895
Lichtenberg-
Ryder T.C
14 cm



EI-4896
Lichtenberg-
Ryder T.C
17 cm



EI-4897
Lichtenberg-
Ryder T.C
17 cm



EI-4898
Barraquer
18 cm



EI-4899
Barraquer
18 cm



EI-4900
Barraquer T.C
18 cm



EI-4901
Barraquer T.C
18 cm



EI-4902
Tönnis
18 cm



EI-4903
Castroviejo
13 cm
Straight



EI-4904
Kalt Needle Holders T.C
14 cm Straight



EI-4905
Peet Splinter Forceps
11.5 cm



EI-4903
La Grange
Curved



EI-4906
All-Purpose Pliers

HAEMOSTATIC FORCEPS & TOWEL CLAMPS

- Зажимы артериальные, зажимы для салфеток
- Pinces hemostatiques, Pincas a compresas
- Arterienklemmen, Tuschklemmen
- Затискачі артеріальні, затискачі для серветок
- Pinzas hemostaticas, Pincas para compresas
- الملقط هايموستاتيک المشابک منشفة

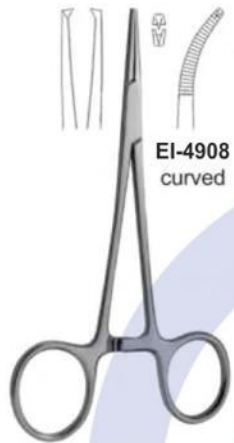

Halstead Mosquito 1x2
EI-4907 125mm
straight



Kelly
EI-4909 140mm
straight

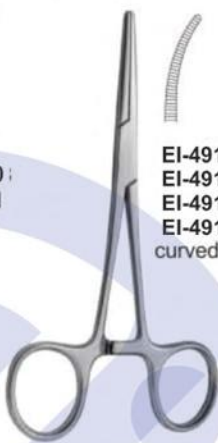

Rochester-Pean
EI-4911 140mm
EI-4912 160mm
EI-4913 180mm
EI-4914 200mm
straight

EI-4915 140mm
EI-4916 160mm
EI-4917 180mm
EI-4918 200mm
curved

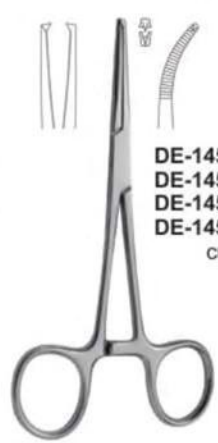

Rochester-Kocher 1x2
EI-4919 140mm
EI-4920 160mm
EI-4921 180mm
EI-4922 200mm
straight

DE-1451 140mm
DE-1452 160mm
DE-1453 180mm
DE-1454 200mm
curved



EI-4923
Kelly-Rankin
160mm
straight

DE-1456
curved



Lorna
EI-4924 100mm
EI-4925 130mm



EI-4926
Allis-Baby 3:4
150mm



EI-4927
Allis 4:5
200mm



EI-4928
Allis 6:7
200mm

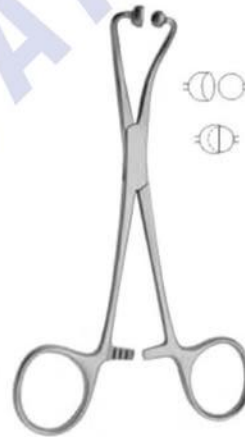

Ball Socket
EI-4929 140mm
Not-perforating and
not-damaging



EI-4930
Backhaus
130mm



EI-4931
Backhaus
85mm



EI-4932
Jones
90mm

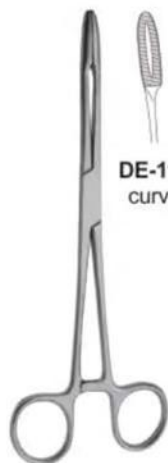

Gross Maier
Dressing Forceps
EI-4933 200mm straight

DE-1139
curved



Foerster
Dressing Forceps
EI-4934 200mm



Young
Tongue Forceps
EI-4935 170mm

Spare rubber



Collins
Tongue Forceps
EI-4936 170mm

RUBBER DAM CLAMPS FORCEPS

- Инструменты для системы коффердам
- Pincas porte-crampons a digue
- Kofferdam Klammerzangen
- Инструменти для системи коффердам
- Pinzas de engrapar para dique de caucho
- السد العظام الملقط المشابك



EI-4937

On request the Content of the rubber dam kit can be changed with other instruments.

Content:

- 01 Anisworth
- 02 Brewer
- 03 Clamps Stand
- 04 Denture Plate
- 05 Rubber Dam Frame
- 06 Rubber Dam Box Lower Case
- 07 Rubber Dam Box Upper Case
- 08 Rubber Dam Clamp Fig. 212
- 09 Rubber Dam Clamp Fig. 211
- 10 Rubber Dam Clamp Fig. 8
- 11 Rubber Dam Clamp Fig. 8A
- 12 Rubber Dam Clamp Fig. 14
- 13 Rubber Dam Clamp Fig. 14A
- 14 Rubber Dam Clamp Fig. 0
- 15 Rubber Dam Clamp Fig. 00
- 16 Rubber Dam Clamp Fig. 2
- 17 Rubber Dam Clamp Fig. 2A
- 18 Rubber Dam Clamp Fig. 7

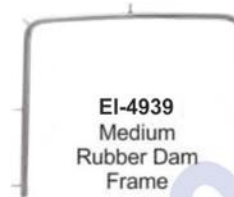
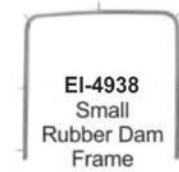

EI-4941
Brewer



EI-4942
Stockes



EI-4943
Palmer



EI-4944
Ivory light weight



EI-4945
Anisworth



EI-4946
Anisworth



EI-4947
Anisworth



EI-4948
Ivory



EI-4949
Separating
Elastic Plier

RUBBER DAM CLAMPS KITS

- Резиновая дамба зажимы комплекты
- Trousses de caoutchouc
- Gummidammklammern
- Гумова дамба затискачі комплекти
- Conjuntos de abrazaderas de retención de caucho
- المطاط السد المشابك مجموعات



EI-4950
Stainless Steel Gold Plated Rubber Dam Clamp Tray with 11 Different Clamps
Fig. 212, 211, 8, 8A, 14, 14A, 0, 00, 2, 2A, 7



EI-4951
Stainless Steel Rubber Dam Clamp Tray with 12 Different Clamps
Fig. 209, 212, 211, 8, 8A, 14, 14A, 0, 00, 2, 2A, 7



EI-4952
Stainless Steel Rubber Dam Clamp Tray with 8 Different Clamps
Fig. 1, 26, 29, 51, 60, 202, 205, 210



EI-4953
Stainless Steel Rubber Dam Clamp Tray
(without clamps)

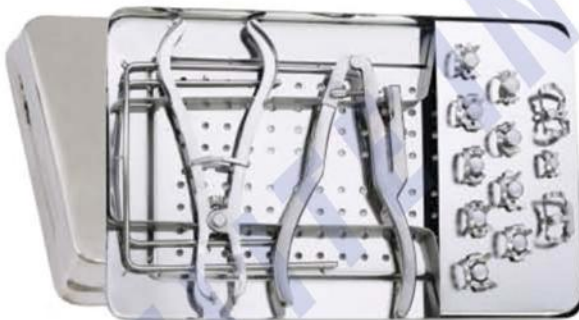

EI-4954
On request the Content of the rubber dam kit can be changed with other instruments.
Content:
01 Ivory
02 Ivory light weight
03 Clamps Stand
04 Rubber Dam Frame M
05 Rubber Dam Frame L
06 Rubber Dam Box Lower Case
07 Rubber Dam Box Upper Case

08 Rubber Dam Clamp Fig. 209
09 Rubber Dam Clamp Fig. 212
10 Rubber Dam Clamp Fig. 211
11 Rubber Dam Clamp Fig. 8
12 Rubber Dam Clamp Fig. 8A
13 Rubber Dam Clamp Fig. 14
14 Rubber Dam Clamp Fig. 14A
15 Rubber Dam Clamp Fig. 0
16 Rubber Dam Clamp Fig. 00
17 Rubber Dam Clamp Fig. 2
18 Rubber Dam Clamp Fig. 2A
19 Rubber Dam Clamp Fig. 7

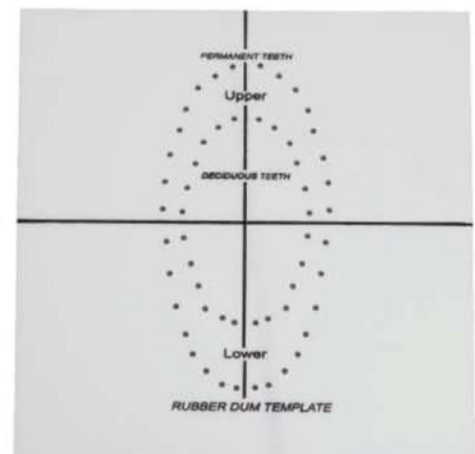

EI-4955
Rubber Dum Template

RUBBER DAM CLAMPS

- Кляммера для коффердама
- Crampons pour digue
- Kofferdam Klammern
- Кляммера для коффердама
- Grapas para dique de caucho
- المشابك السد المطاط



EI-4956
Fig. 15



EI-4957
Fig. 18



EI-4958
Fig. 24



EI-4959
Fig. 25



EI-4960
Fig. 26



EI-4961
Fig. 28



EI-4962
Fig. 30



EI-4963
Fig. 31



EI-4964
Fig. 51



EI-4965
Fig. 138



EI-4966
Fig. 139

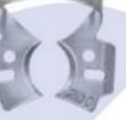

EI-4967
Fig. 200



EI-4968
Fig. 201



EI-4969
Fig. 202



EI-4970
Fig. 203



EI-4971
Fig. 204



EI-4972
Fig. 205



EI-4973
Fig. 3



EI-4974
Fig. W3



EI-4975
Fig. 4



EI-4976
Fig. 56A



EI-4977
Fig. 7



EI-4978
Fig. 7A



EI-4979
Fig. 8



EI-4980
Fig. 8A



EI-4981
Fig. W8A



EI-4982
Fig. 10



EI-4983
Fig. 11



EI-4984
Fig. 12A



EI-4985
Fig. 13A



EI-4986
Fig. 14



EI-4987
Fig. 14A



EI-4988
Fig. 14AN



EI-4989
Fig. 22



EI-4990
Fig. 27



EI-4991
Fig. 207



EI-4992
Fig. 29



EI-4993
Fig. 206



EI-4994
Fig. 208



EI-4995
Fig. 209



EI-4996
Fig. 1



EI-4997
Fig. 1A



EI-4998
Fig. 2



EI-4999
Fig. 2A



EI-5000
Fig. W2A



EI-5001
Fig. 0



EI-5002
Fig. 00



EI-5003
Fig. 210



EI-5004
Fig. 211



EI-5005
Fig. 212



EI-5006
Fig. 6



EI-5007
Fig. 9



EI-5008
Fig. N06



EI-5009
Fig. U67



EI-5010
Fig. 214



EI-5011
Fig. P1



EI-5012
Fig. P2



EI-5013
Fig. G-1



EI-5014
Fig. G-2

CROWN REMOVER

- Инструменты для удаления коронок
 - Arrache-couronnes
 - Teleskopkronenzangen
- Инструменты для видалення коронок
 - Arranca-corona
 - مزيلات التاج



EI-5015
Crown Spreaders



EI-5015
Universal
Fig. 0



Manual Crown Removers



EI-5016 **EI-5017**



EI-5018



Manual Crown Removers



EI-5019 **EI-5020**



EI-5021



EI-5022
Manual Crown
Remover



EI-5023
Manual Crown Remover



EI-5024
Complete with 3 tips
and tightening keys

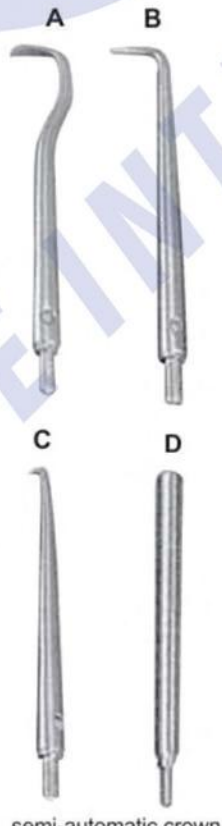

semi-automatic crown
& bridge remover



EI-5025



A **B**



EI-5026
Manual Crown Remover



A **B** **C**



D **E**

MATRIX RETAINERS

- Матрицедержатели
 - Porte Matrices
 - Matrizenspanner
- Матрицеутримувачи
 - Porta Matrices
 - مصفوفة الخدم



AMALGAM INSTRUMENTS

- Инструменты для амальгамы
- Instruments pour amalgame
- AmalgamisInstrumente
- Инструменти для амальгами
- Instrumentos para amalgama
- الصكوك الملغم

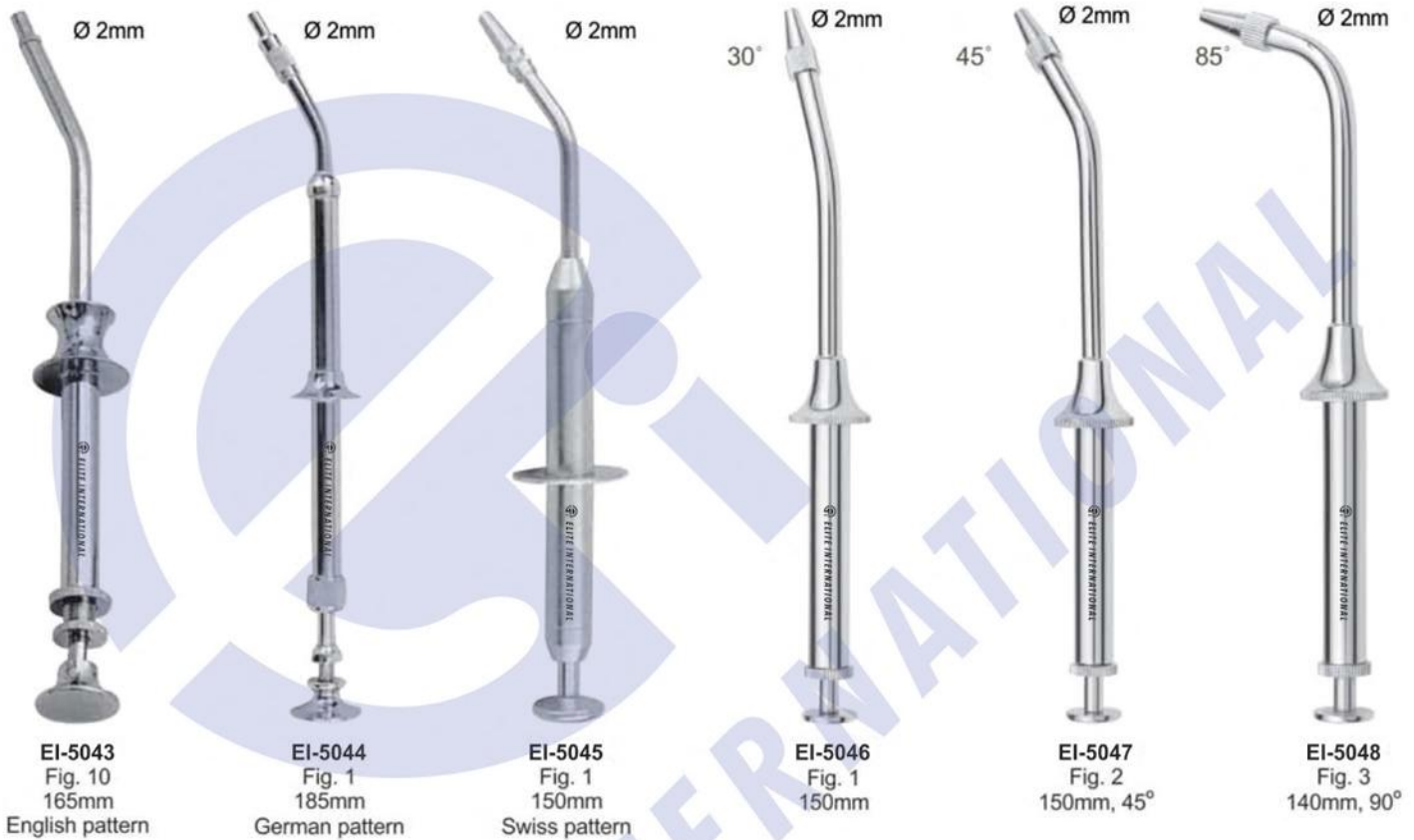

AMALGAM INSTRUMENTS

- Инструменты для амальгамы
- Instruments pour amalgame
- Amalgam-Instrumente
- Инструменты для амальгами
- Instrumentos para amalgama
- الصوك المنقعم

AMALGAM CARRIERS

TIP SIZES FOR DISTAL OR SINGLE-END

1.5 mm

2.0 mm

2.8 mm

1.5 mm

2.0 mm



EI-5054
Single-End



EI-5055
Mini/
Single-End



EI-5056
Regular
Single-End



EI-5057
Large
Single-End



EI-5058
Mini
Distal



EI-5059
Regular
Distal

TIP SIZES FOR DOUBLE-END

1.5 mm

2.8 mm

3.2 mm



2.0 mm
EI-5060
Mini/
Regular



2.0 mm
EI-5061
Large/
Regular



2.0 mm
EI-5062
Jumbo/
Regular



EI-5063
Amalgam
Well

TIP SIZES FOR DOUBLE-END



DE-1601 - 1.5mm-2.0mm
DE-1602 - 2.0mm-2.8mm
DE-1603 - 2.0mm-3.2mm

EI-5064 - 1.0mm-2mm
EI-5065 - 2.0mm-3mm
EI-5066 - 2.0mm-4mm



DE-1607 - 1.5mm-2.0mm
DE-1608 - 2.0mm-2.8mm
DE-1609 - 2.0mm-3.2mm

EI-5067 - 1.0mm-2mm
EI-5068 - 2.0mm-3mm
EI-5069 - 2.0mm-4mm



DE-1613 - 1.5mm-2.0mm
DE-1614 - 2.0mm-2.8mm
DE-1615 - 2.0mm-3.2mm

EI-5070 - 1.0mm-2mm
EI-5071 - 2.0mm-3mm
EI-5072 - 2.0mm-4mm



DE-1619 - 1.5mm-2.0mm
DE-1620 - 2.0mm-2.8mm
DE-1621 - 2.0mm-3.2mm

EI-5073 - 1.0mm-2mm
EI-5074 - 2.0mm-3mm
EI-5075 - 2.0mm-4mm



EI-5076 - 1.5mm
EI-5077 - 2.0mm
EI-5078 - 2.0mm
EI-5079 - 3.0mm

CHISELES, BONE FILES & SPOONE CURETTE



ROOT PLANNING FILES



EI-5092
Kramer-Nevins
Bone Chisel



EI-5093
Kramer-Nevins
Bone Chisel



EI-5094
Molt 18.5cm
Auto Clavable
Plastic Tips.



EI-5095
Mead 18.5cm
Non Auto Clavable
Plastic Tips.



EI-5096
Miller



EI-5097
Miller

BONE FILES



EI-5098
Miller 21



EI-5099
Miller 1X
cross cut



EI-5100
Miller 2X
cross cut



EI-5101
Miller 52



EI-5102
Wahl 1

PERIODONTAL INSTRUMENTS

- Инструменты пародонтологические
- Instruments pour la parodontologie
- Instrumente für die Parodontologie
- Інструменти пародонтологічні
- Intrumentos para periodoncia
- الصكوك اللثة

PERIOSTEEL ELEVATORS



EI-5103
Ohl 10



EI-5104
Howard 9H



EI-5105
Freer

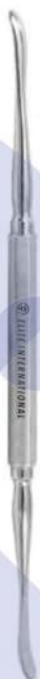

EI-5106
Freer 15



EI-5107
Freer 16



EI-5108



EI-5109
Raspator, Raspatory
Length 175 mm



EI-5110



EI-5111

Raspator, Williger
Length 170 mm, different widths
(4 mm, 5 mm or 7 mm)



EI-5112



EI-5113



Partsch 140 mm
EI-5114 3mm
EI-5115 4mm
EI-5116 5mm
EI-5117 6mm



Partsch 170 mm
EI-5118 3mm
EI-5119 4mm
EI-5120 5mm
EI-5121 6mm



Partsch 140 mm
EI-5122 3mm
EI-5123 4mm
EI-5124 5mm
EI-5125 6mm

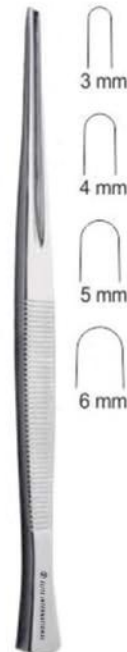

Partsch 170 mm
EI-5126 3mm
EI-5127 4mm
EI-5128 5mm
EI-5129 6mm

PERIODONTAL INSTRUMENTS

- Инструменты пародонтологические
- Instruments pour la parodontologie
- Instrumente für die Parodontologie
- Інструменти пародонтологічні
- Instrumentos para periodoncia
- الصكوك اللثة

To separate tissue tooth or bone. tp hold tissue away from surgical site.

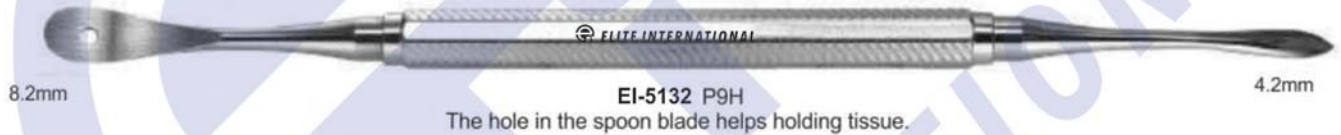

PERIODONTAL INSTRUMENTS

- Инструменты пародонтологические
- Instruments pour la parodontologie
- Instrumente für die Parodontologie
- Інструменти пародонтологічні
- Instrumentos para periodoncia
- الصكوك اللثة



EI-5140



EI-5141
P24G



EI-5142
titanium Periosteal Elevator for Implan5



EI-5143
S1



EI-5144
Hirschfeld



EI-5145
9S



10mm

EI-5146
Selden

13mm



4.8 MM

Prichard

10.6 MM

EI-5147
Friedmann



EI-5148
Schmidlin

6.9 MM

SCALPEL HANDLES

- Ручки для скальпелей
- Manches de bistouris
- Skalpellgriffe
- Ручки для скальпелів
- Mangos de bisturi
- مشرط مقابض



EI-5149
Fig.3
12.7cm



EI-5150
Fig.3G
12.7cm



EI-5151
Fig.4
13.7cm



EI-5152
Double Handle
No.4 + No.3
16.3cm



EI-5153
Fig. 7
16.5cm



EI-5154
Scalpel Handle Straight
for blades #10-15
14.5cm



EI-5155
Micro Surgical Scalpel
Handle titanium
13.5cm



EI-5156
Fig. 5
14.5cm



EI-5157
Fig. 5A
14.5cm



EI-5158
6 Way Adjustable Angled
Scalpel Handle

MALLETS - PLASTER SHEARS - SAWS & BLADES



EI-5159
Metal tip
220 mm
Hammer With Wooden Handle



EI-5160
Metal tip
220 mm



EI-5161
1
For plaster



EI-5162
2
For metal



EI-5163
Fret saw
250 mm



EI-5164
Small
Saw Blades



EI-5165
Large
Saw Blades



EI-5166
Ceri Saw



Special Inox
EI-5167 170mm
EI-5168 200mm



EI-5169
Plaster Shears
200 mm



Crucible Tongs
EI-5170 250 mm
EI-5171 320 mm



EI-5172
Ceri Saw
180 mm



EI-5173
Blade
0,12x5 mm
Conf. 12 pcs



EI-5174
Blade
0,25x5 mm
Conf. 12 pcs



EI-5175
Blade
0,25x3 mm
Conf. 12 pcs



Behind Every Smile is a Story

- QUALITY - ЯКІСТЬ
- PRECISION - ТОЧНІСТЬ
- ACCURACY - ПРАВИЛЬНІСТЬ
- DURABILITY - ЗНОСОСТІЙКІСТЬ



ORTHODONTIC INSTRUMENTS

- Инструменты ортодонтические
- Instrumentos Ortodonticos
- Orthodontische Instrumente
- Инструменти ортодонтични
- Instruments Orthodontiques
- ادوات تقويم الاسنان



EI-5176
Height Gauge 0.18
Aluminum



EI-5177
Height Gauge 0.22
Aluminum



EI-5178
Height Gauge 0.18
Stainless Steel



EI-5179
Height Gauge 0.22
Stainless Steel



EI-5180
Moveable
Height Gauge



EI-5181
Endo Finger
Ruler Span
Measure Scale



EI-5182
Endo Finger
Ruler Span
Measure Scale



EI-5183
Endo Finger
Ruler Span
Measure Scale



EI-5184
Positive
Postioner



EI-5185
Strip Saw



EI-5186
Bone Bracket Gauge



EI-5187
Endo Finger Ruler
Span Measure Scale



EI-5188
Endo Finger Ruler
Span Measure Scale

ORTHODONTIC INSTRUMENTS

- Инструменты ортодонтические
- Instrumentos Ortodonticos
- Orthodontische Instrumente
- Инструменти ортодонтични
- Instruments Orthodontiques
- أدوات تقويم الأسنان



EI-5189
Measuring Loop
angled, length
175 mm,
measuring range
0 - 40 mm



EI-5190
Measuring Loop
straight length
175 mm,
measuring range
0 - 40 mm



EI-5191
Measuring loop, Castroviejo
angled, length 175 mm,
measuring range 0 - 40 mm,
with window



EI-5192
Measuring Loop
straight length 90 mm,
measuring range
0 - 40 mm,

EI-5193
Castroviejo Calipers
20mm
90mm



EI-5194
Measuring Loop
angled, length 90 mm,
measuring range
0 - 40 mm,

EI-5195
Castroviejo Calipers
20mm, 45°
90mm



EI-5196
Castroviejo Calipers
20mm
90mm



EI-5197
Fig. 1
Iwanson
spring caliper
For metal and
porcelain.



EI-5198
Fig. 2
Iwanson
spring caliper
For wax.

ORTHODONTIC INSTRUMENTS

- Инструменты ортодонтические
- Instrumentos Ortodonticos
- Orthodontische Instrumente
- Инструменти ортодонтични
- Instruments Orthodontiques
- أدوات تقويم الأسنان



EI-5199
Boley Gauge



EI-5200
Vernier Gauge



EI-5201
Aluminium Caliper
up to 200mm



EI-5202
Boley Gauge



EI-5203
Delux Boley
Gauge



EI-5204
Beerendonk
130mm
Mini Gauge



EI-5205
Compasso
De Willis



EI-5206
Dentaurum
Ruler



EI-5207
Ruler Wedge



EI-5208
Ruler

ORTHODONTIC INSTRUMENTS

- Инструменты ортодонтические
- Instrumentos Ortodonticos
- Orthodontische Instrumente
- Инструменти ортодонтични
- Instruments Orthodontiques
- ادوات تقويم الأسنان

Bracket Holder Tweezers



EI-5209
Deluxe Bracket
Holder Tweezers



EI-5210
Deluxe Bracket
Holder Tweezers



EI-5211
Direct Bond Bracket
Holder Tweezers



EI-5212
Bracket Tweezers
Slot Aligner



EI-5213
Direct Bond
Bracket Holder
Tweezers, Small Tip



EI-5214
Exact Bracket
Holder Tweezers



EI-5215
Bracket Placing
Tweezers



EI-5216
Easy Access
Tweezers



EI-5217
Bracket Placer
Tweezers
(Extra Fine Tip)



EI-5218
Deluxe Bracket
Holder Tweezers
135mm



EI-5219
Easy Eccess
Tweezers



EI-5220
Slipper
Tweezers



EI-5221
Direct Bonding
Bracket Holders
135mm



EI-5222
Direct Bonding
Bracket Holders
136mm



EI-5223
Direct Bonding
Bracket Holders
135mm



EI-5224
Deluxe Bracket
Holder



EI-5225
Direct Bonding
Bracket Holders
140mm

ORTHODONTIC INSTRUMENTS

- Инструменты ортодонтические
 - Instrumentos Ortodonticos
 - Orthodontische Instrumente
- Инструменти ортодонтични
 - Instruments Orthodontiques
 - ادوات تقويم الأسنان



EI-5226
Band seater
auto cleavable



EI-5227
Band seater
auto cleavable
Triangle Shape



EI-5228
Band seater
auto cleavable
Square Shape



EI-5229
Band seater
auto cleavable
Round Shape



EI-5230
Mershon Band
Pusher
140mm



EI-5231
Band seating &
removing
instruments



EI-5232
Ortho Light double
ended
ligature director
scaler



EI-5233
Ortho Light Band
Pusher Scaler



EI-5234
Band Seating &
Removing
Silicon Grip



EI-5235
Ligature Instrument
Silicon Grip



EI-5236
Elastic Instrument
Silicon Grip



EI-5237
Distal Bender
Silicon Grip



EI-5238
Distal Bender
Silicon Grip



EI-5239
Distal Bender
Silicon Grip

ORTHODONTIC INSTRUMENTS

- Инструменты ортодонтические
- Instrumentos Ortodonticos
- Orthodontische Instrumente
- Инструменти ортодонтични
- Instruments Orthodontiques
- ادوات تقويم الأسنان



EI-5240

Ortho light scaler double ended



EI-5241

Ortho light scaler double ended



EI-5242

Ortho light scaler double ended



EI-5243

Twiel-on elastic module instrument



EI-5244

Twiel-on elastic module instrument



EI-5245

Schure Band Seater



EI-5246

Ortho light scaler



EI-5247

Ortho light scaler



EI-5248

Ortho light scaler heavy



EI-5249

Ortho instrument



EI-5250

Ortho instrument

ORTHODONTIC INSTRUMENTS

- Инструменты ортодонтические
- Instrumentos Ortodonticos
- Orthodontische Instrumente
- Инструменти ортодонтични
- Instruments Orthodontiques
- ادوات تقويم الأسنان



EI-5251
Ortho Light double ended
ligature director



EI-5252
Ortho Light double ended ligature scaler director tivate coil spring
are remove modules with one instruments



EI-5253
Ortho band pusher scaler



EI-5254
Ortho ligature director single ended



EI-5255
Ortho Light double ended ligature
director scaler



EI-5256
Ortho Light double ended ligature scaler/director
tivate coil spring are remove modules with one instruments



EI-5257
Ortho Light double ended ligature director



EI-5258
Ortholite Ligature Director Scaler



EI-5259
Ortho light ligature director double ended



EI-5260
Double ended cement spatula



EI-5261
Ortho light scaler single ended

PLIERS FOR ORTHODONTICS & PROSTHETICS

- Щипцы для ортодонтии и протезирования
- Щипці для ортодонції та протезування
- Pincers pour l'orthodontie et la prothèse
- Alicates para ortodoncia y prótesis
- Zangen für Kieferorthopädie und Prothetik
- كمانشة لتكوين الأسنان بروتستيس

BOX JOINT PLIERS

EI-5262
Universal Dolphin Style
Wire Bending & cutting pliers



EI-5263 Band Removing Plier
The curved blade of the band removing plier can strip easily and gently remove directly to the tooth. Length 130mm



EI-5264
Tweed Loop forming Pliers



EI-5265 How Plier curved
Universally usable tool for the multiband technology for wires up to .028". Length 130mm



EI-5266 How Plier
Universally usable tool for the multiband technology for wires up to .028". Length 135mm



EI-5267
Nance Loop forming Pliers



EI-5268
Bracket Removing Plier curved
Bracket Removing Plier curved for easy removal of brackets in the posterior region. Length 130mm



EI-5269
Young Wire Bending & Loop Forming Pliers



EI-5270
Wire Bending & Loop Forming Pliers



EI-5271
Adams, small wire bending and loop forming Pliers



EI-5272
Bracket Removing Plier Round Box
Bracket removing plier for comfortable and quick removal of the brackets. Length 135mm



EI-5273
Weingart Plier medium
Weingart plier that are ideal due to their curved tip for setting sheets and is capable of bending the ends. Length 145mm



PLIERS FOR ORTHODONTICS & PROSTHETICS

- Щипцы для ортодонтии и протезирования
- Pincers pour l'orthodontie et la prothèse
- Zangen für Kieferorthopädie und Prothetik
- Щипці для ортодонції та протезування
- Alicates para ortodoncia y prótesis
- كمشاة لتقويم الأسنان بروتستیس

BOX JOINT PLIERS

EI-5274 Adams Plier Round Box

Adams pliers for bending wire arches and bends right angles for wires up to .022", .025 tip to beak. Length 125mm



EI-5280 Adams Plier

Adams pliers for bending wire arches and bends right angles for wires up to .022", .025 tip to beak. Length 125mm



EI-5275

Falcon Beak Contouring Pliers.



EI-5281

Tweed Loop Formin Pliers



EI-5276

wires up to 0.020" / 0.7mm.



EI-5282 Bird Beak Plier Standard

Bird Beak Wire bending plier without notches, which is suitable as a universal utility tool. Length 125mm



EI-5277

Johnson Contouring Pliers



EI-5283

Mini Ligature cutters



EI-5278 Aderer

Large wire bending and loop forming pliers



EI-5284 Small

Fluch-cut distal and cutting Pliers with safety hold fitted with un-breakable, corrosion resistant and durable stainless steel tips



EI-5279

Tweed / angle rectangular arch forming & Torquing pliers



EI-5285 Large

Fluch-cut distal and cutting Pliers with safety hold fitted with un-breakable, corrosion resistant and durable stainless steel tips



PLIERS FOR ORTHODONTICS & PROSTHETICS

- Щипцы для ортодонтии и протезирования
- Pincers pour l'orthodontie et la prothèse
- Zangen für Kieferorthopädie und Prothetik
- Щипці для ортодонції та протезування
- Alicates para ortodoncia y prótesis
- كمشة لتقويم الأسنان بروستھتیس

BOX JOINT PLIERS

EI-5286

Tweed / Angel

1.78mm (.070") wide tips arch forming and torquing pliers



EI-5292

Contouring Plier



EI-5287

Tweed / Angel

1.78mm (.070") wide tips arch forming and torquing pliers



EI-5293

Bands & Crowns Plier
in order to skirt



EI-5288

Lingual / Palatal arch
forming pliers



EI-5294

Ligature Forming Pliers



EI-5289

Aderer

Facebow loop forming Pliers



EI-5295

for double back and triple back bands in 0.30" / 0.76mm & 0.36" / 0.91mm lingual arch wires



EI-5290

Waldsavhs wire bending and cutting pliers



EI-5296

Bird Beak Wire Bending & cutting pliers

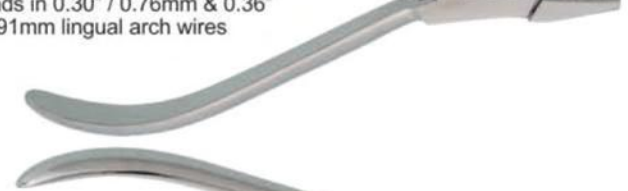

EI-5291 | **Aderer Plier**

For the manufacturing of appliances and activation of wires for wires up to .030" .fine tip and up to .036" mean tip.
Length 130mm



EI-5297

Weingart Plier medium

Weingart plier that are ideal due to their curved tip for setting sheets and is capable of bending the ends.
Length 145mm



PLIERS FOR ORTHODONTICS & PROSTHETICS

- Щипцы для ортодонтии и протезирования
- Pincers pour l'orthodontie et la prothèse
- Zangen für Kieferorthopädie und Prothetik
- Щипці для ортодонції та протезування
- Alicates para ortodoncia y prótesis
- كمشة لتقويم الأسنان بروسیتیس

L-KEY JOINT PLIERS



EI-5298

Distal end cutter with safety hold, mini head, long handles. fitted with un-breakable, corrosion resistant and durable stainless steel tips

- 0.30 mm to 0.50 mm (.012" to .020")
- Max. 0.46 mm x 0.64 mm (.018" x .025")
- ⊗ 0.38 mm to 0.53 mm (.0155" to .0215")
- ⊗ Max. 0.53 mm x 0.64 mm (.021" x .025")



EI-5302

Soft wire and ligature cutter, 15° angled fitted with un-breakable, corrosion resistant and durable stainless steel tips

- ⌋ .25 mm to .38 mm (.010" to .015")



EI-5299

Flush-cut distal end cutter with safety hold fitted with un-breakable, corrosion resistant and durable stainless steel tips

- 0.30 mm to 0.50 mm (.012" to .020")
- Max. 0.46 mm x 0.64 mm (.018" to .025")



EI-5303

Soft wire and ligature cutter, 45° angled fitted with un-breakable, corrosion resistant and durable stainless steel tips

- ⌋ .25 mm to .38 mm (.010" to .015")



EI-5300

Soft wire and ligature cutter, Mini fitted with un-breakable, corrosion resistant and durable stainless steel tips

- ⌋ .25 mm to .38 mm (.010" to .015")



EI-5304

Hard wire cutter, straight Fitted with un-breakable, corrosion resistant and durable stainless steel tips

- 0.30 mm to 0.50 mm (.012" to .020")
- Max. 0.56 mm x 0.71 mm (.022" x .028")



EI-5301

Soft wire and ligature cutter, standard fitted with un-breakable, corrosion resistant and durable stainless steel tips

- ⌋ .25 mm to .38 mm (.010" to .015")



EI-5306

Hard wire cutter, 15° angled Non-autocalavable

- 0.30 mm to 0.50 mm (.012" to .020")
- Max. 0.56 mm x 0.71 mm (.022" x .028")



EI-5305

Hard wire cutter, 15° angled Fitted with un-breakable, corrosion resistant and durable stainless steel tips



















- 0.30 mm to 0.50 mm (.012" to .020")
- Max. 0.56 mm x 0.71 mm (.022" x .028")



PLIERS FOR ORTHODONTICS & PROSTHETICS

- Щипцы для ортодонтии и протезирования
- Щипці для ортодонтії та протезування
- Pincers pour l'orthodontie et la prothèse
- Alicates para ortodoncia y prótesis
- Zangen für Kieferorthopädie und Prothetik
- كمشة لتقويم الأسنان بروتیسیس

L-KEY JOINT PLIERS

	 <p>EI-5307 Band removing pliers</p>		 <p>EI-5312 Weingart-mini Utility Pliers</p> <ul style="list-style-type: none"> ● 0.30 mm to 0.50 mm (.012" to .020") ■ Max 0.56 mm x 0.71 mm (.022" x .028")
	 <p>EI-5308 Bracket removing pliers angled</p>		<p>EI-5313 Weingart Utility Pliers</p> <ul style="list-style-type: none"> ● 0.30 mm to 0.50 mm (.012" to .020") ■ Max 0.56 mm x 0.71 mm (.022" x .028")
	 <p>EI-5309 Bracket removing pliers straight</p>		 <p>EI-5314 How Straight Utility Pliers</p> <ul style="list-style-type: none"> ● 0.30 mm to 0.50 mm (.012" to .020") ■ Max 0.56 mm x 0.71 mm (.022" x .028")
	 <p>EI-5310 Bracket removing pliers with plastic tip</p>		<p>EI-5315 Angled Utility Pliers</p> <ul style="list-style-type: none"> ● 0.30 mm to 0.50 mm (.012" to .020") ■ Max 0.56 mm x 0.71 mm (.022" x .028")
	 <p>EI-5311 Adhesive removing pliers</p>		 <p>EI-5316 Wire bending and loop forming pliers Angled (Bird beak)</p> <ul style="list-style-type: none"> ● 0.30 mm to 0.50 mm (.012" to .020") ■ Max 0.56 mm x 0.71 mm (.022" x .028")

PLIERS FOR ORTHODONTICS & PROSTHETICS

- Щипцы для ортодонтии и протезирования
- Pincers pour l'orthodontie et la prothèse
- Zangen für Kieferorthopädie und Prothetik
- Щипці для ортодонції та протезування
- Alicates para ortodoncia y prótesis
- كمشة لتقويم الأسنان بروستیتیس

L-KEY JOINT PLIERS



EI-5317
Multi-purpose pliers, bird beak,
De la rosa and cutter in one

- 0.30 mm to 0.50 mm (.012" to .020")
- Max. 0.46 mm x 0.56 mm (.018" x .022")



EI-5322
Stop pliers V-Bebd - 1mm

- 0.30 mm to 0.50 mm (.012" to .020")
- Max. 0.43 mm x 0.56 mm (.017" x .028")



EI-5318
Cinch Back / tie back
Distal end bending pliers

- 0.30 mm to 0.50 mm (.012" to .020")
- Max. 0.56 mm x 0.71 mm (.022" x .028")

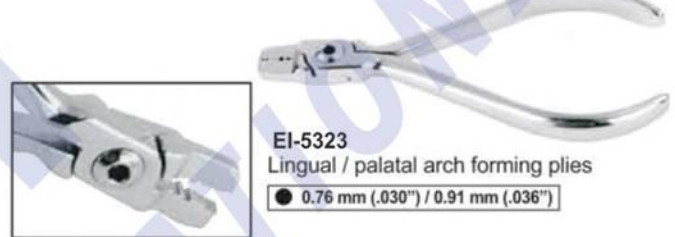

EI-5323
Lingual / palatal arch forming plies

- 0.76 mm (.030") / 0.91 mm (.036")



EI-5319
Hammer head
Distal end bending pliers

- 0.30 mm to 0.50 mm (.012" to .020")
- Max. 0.56 mm x 0.71 mm (.022" x .028")



EI-5324
Torquing pliers set

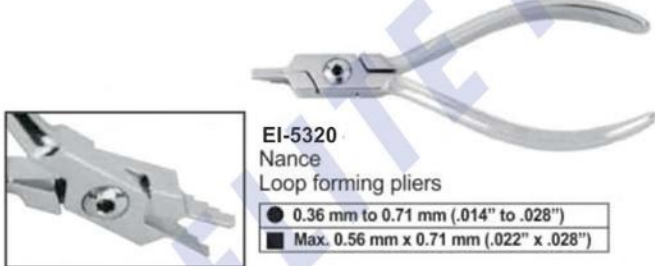

EI-5320
Nance
Loop forming pliers

- 0.36 mm to 0.71 mm (.014" to .028")
- Max. 0.56 mm x 0.71 mm (.022" x .028")



EI-5325
Tweed / angel
Rectangular arch forming and
torquing pliers

- 0.30 mm to 0.71 mm (.012" to .028")
- Max. 0.56 mm x 0.71 mm (.022" x .028")



EI-5321
Detailing step pliers / Bayonet
bending pliers - 1mm

- 0.30 mm to 0.50 mm (.012" to .020")
- Max. 0.56 mm x 0.71 mm (.022" x .028")

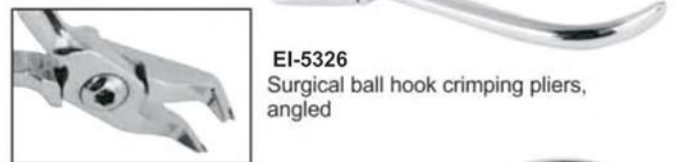

EI-5326
Surgical ball hook crimping pliers,
angled

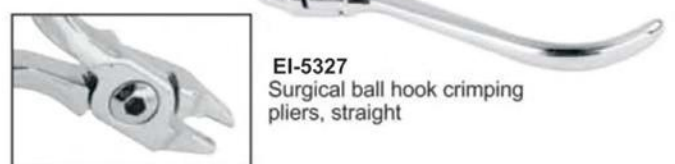

EI-5327
Surgical ball hook crimping
pliers, straight

PLIERS FOR ORTHODONTICS & PROSTHETICS

- Щипцы для ортодонтии и протезирования
- Pincers pour l'orthodontie et la prothèse
- Zangen für Kieferorthopädie und Prothetik
- Щипці для ортодонції та протезування
- Alicates para ortodoncia y prótesis
- كمشة لتقويم الأسنان بروتستیس

L-KEY JOINT PLIERS

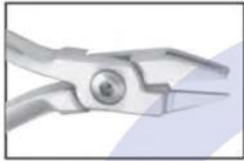

EI-5328
Aderer Clamp three jaw wire bending plier for contouring and bending wire up to .30"/.76mm.



EI-5334
Falcon beak contouring plier.

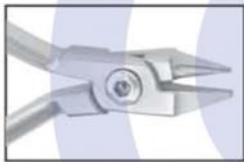
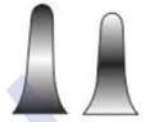

EI-5329
Bird beak plier for bending round, square and rectangle wire up to .30"/.76mm.

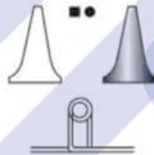

EI-5335
For placement and removal of arch wires, pins and other auxiliaries.

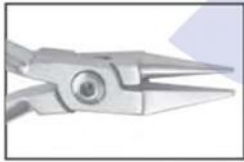

EI-5330
Bird beak plier for light wire bending round, square and rectangular up to .016"/0.41mm.

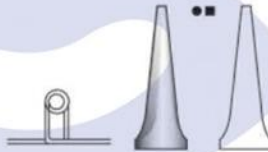

EI-5336
For placement and removal of arch wires, pins and other auxiliaries in angle design



EI-5331
Double Rounded jaw bending pliers, hooks and wire up to .020"/0.51mm.

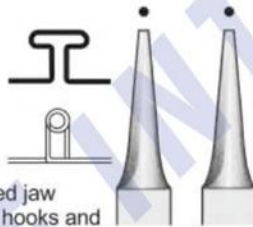

EI-5337
contouring Plier.



EI-5338
Bending plier. In order to skirt molares bands. With grooved. Recommended wire. 016", 018" and 022" 0.41mm, 0.46mm and 0.56mm



EI-5332
Adams pliers for hooks and bending wire up to .030"/0.76mm.

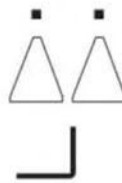

EI-5339
Loop forming in four length 3,4,5 & 6 mm wire capacity 0.22", 56mm.

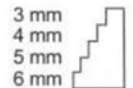

EI-5333
Johnson pliers for crown band contouring



EI-5340
Arch bending plier design for convenient handling of square or rectangular wire, .020" / 0.51mm.



PLIERS FOR ORTHODONTICS & PROSTHETICS

- Щипцы для ортодонтии и протезирования
- Pincas pour l'orthodontie et la prothèse
- Zangen für Kieferorthopädie und Prothetik
- Щипці для ортодонції та протезування
- Alicates para ortodoncia y prótesis
- كاشطة لتقويم الأسنان بروستیتیس

LAP & L-KEY JOINT PLIERS

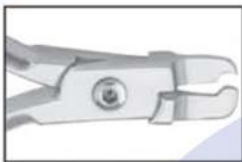

EI-5341
In order to skirt bands and crowns.



EI-5342
Wires up to .020" / 0.7mm.

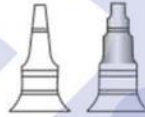

EI-5343
Round and concave plier for loop forming and banding wire up to .20" / .051mm.

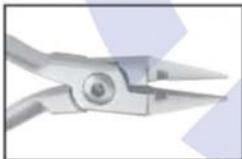

EI-5344
Bending for round square or rectangular wire up to 0.30"/0.76mm



EI-5345
for double back and triple back bands in 0.30" / .76mm & 0.36" / .91mm lingual arch wires.



EI-5346
Detailing step plier double-sided offset beak permits bayonet bends. Creates right hand or left hand step-up or stepdown at 1/2, 3/4, or 1mm increments.



EI-5347
"V" bend stop special design makes 1mm "V" bends to shorten archwires or provide a positive stop. Excellent for placing stops in titanium wires. For round or rectangular wires up to .025"



EI-5348
Angle how plier efficient utility plier with serrated beaks for a firm grip. 45 angled tips to access hard to reach areas.



EI-5349
Weingardt plier serrated tips hold wires firmly at a convenient working angle. Tapered beaks fit easily between brackets and hard to reach areas. Our most popular utility plier.



EI-5350
Pin & Ligature Cutters TC.



EI-5351
Mini Pin & Ligature Cutter TC.



EI-5352
Standard Ligature Cutter TC.



EI-5353
V Bend Stop Plier TC.



EI-5354
Angled Direct Bond Bracket Remover TC.



EI-5355
Cutter Str.



Distal Cutter
14cm
EI-5356 2.5 mm
EI-5357 3.0 mm
EI-5358 3.0 mm



EI-5359
Arrow Clasp Forming Pliers
12.0cm



EI-5360
Schwarz
12.5cm

EI-5361
Distal end Cutter, Safety Hold Plier
(Ideal for Cutting Wire) TC.



EI-5362
Hook Crimping Plier Angled
Straight TC.

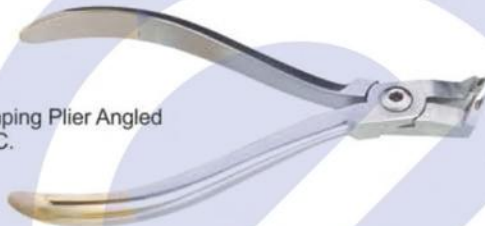

EI-5363
3 Prong Clasp Adjustable
Plier TC.



EI-5364
Utility Plier Weingart TC.



EI-5365
Direct Bracket Remover
TC.



EI-5366
Straight Direct Bond Bracket
Remover TC.



EI-5367
Pin Holding Plier TC.



EI-5368
Hard wire cutters



EI-5369
Elastic Separating Plier
Round Handle



EI-5370
Elastic
Separating Plier



EI-5371 Str.
EI-5372 Cvd.
Smaha
Elastomeric
ligature
placing forceps
140 mm



EI-5373
Elastomeric
ligature
placing
forceps with
groove
Falcon 140 mm



EI-5374
Elastomeric
ligature
placing
forceps with
groove
Falcon 140 mm



PLIERS FOR ORTHODONTICS & PROSTHETICS

- Щипцы для ортодонтии и протезирования
- Pincers pour l'orthodontie et la prothèse
- Zangen für Kieferorthopädie und Prothetik
- Щипці для ортодонції та протезування
- Alicates para ortodoncia y prótesis
- كمشة لتقويم الاسنان بروتیثیس

CUTTER, UTILITY PLIERS & WIRE FORMING PLIERS

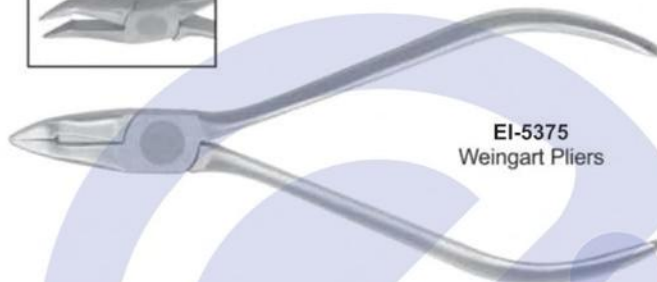

EI-5375
Weingart Pliers



EI-5380
Adhesive
Removing Pliers

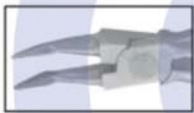

EI-5376
Slim Weingart
Pliers



EI-5381
Posterior Band Removing
Pliers - Long



EI-5377
How Pliers
Straight

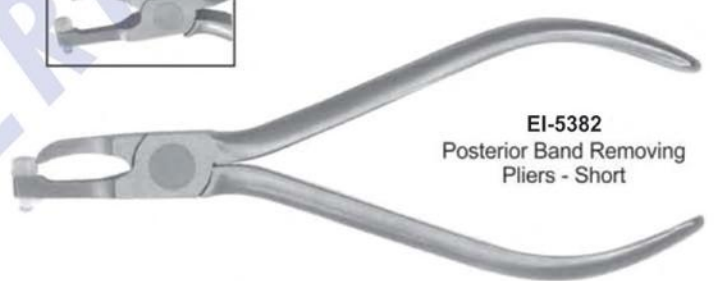

EI-5382
Posterior Band Removing
Pliers - Short



EI-5378
How Pliers Offset

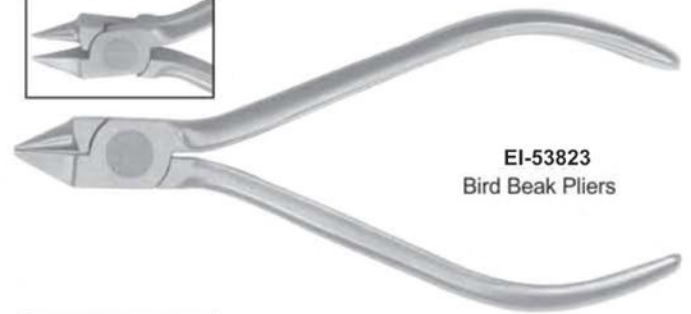

EI-53823
Bird Beak Pliers

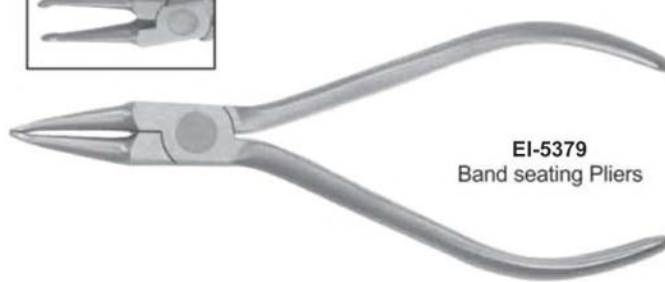

EI-5379
Band seating Pliers



Replacement tip and
hex key included.



EI-5384
Omega Loop
Forming Pliers

PLIERS FOR ORTHODONTICS & PROSTHETICS

- Щипцы для ортодонтии и протезирования
- Pincers pour l'orthodontie et la prothèse
- Zangen für Kieferorthopädie und Prothetik
- Щипці для ортодонції та протезування
- Alicates para ortodoncia y prótesis
- كمشة لتقويم الأسنان بروتیسیس

CUTTERS



EI-5385
Hard
Wire Cutter 15



EI-5389
Mini Pin &
Ligature Cutter

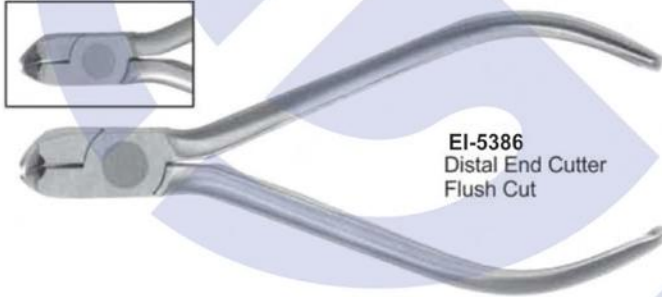
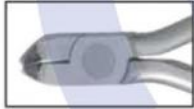

EI-5386
Distal End Cutter
Flush Cut



EI-5390
Hard Wire Cutter
Straight



EI-5387
Universal Cut & Hold
Distal End Cutter



EI-5391
Micro-Mini Pin &
Ligature Cutter



EI-5388
Pin & Ligature
Cutter



EI-5392
Cutter

PLIERS FOR ORTHODONTICS & PROSTHETICS

- Щипцы для ортодонтии и протезирования
- Pincettes pour l'orthodontie et la prothèse
- Zangen für Kieferorthopädie und Prothetik
- Щипці для ортодонції та протезування
- Alicates para ortodoncia y prótesis
- كمشة لتقويم الأسنان بروستھتیس

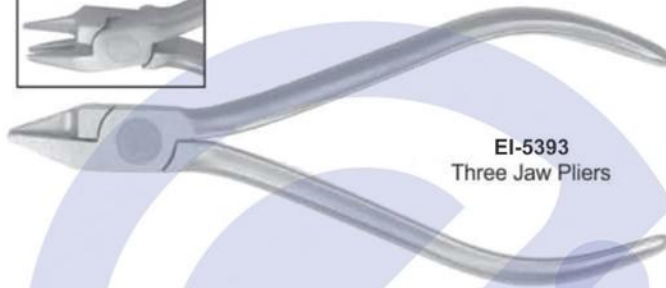

EI-5393
Three Jaw Pliers



EI-5397
Jarabak Pliers

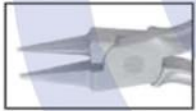

EI-5394
Light Wore Bird Beak
Pliers with Groove



EI-5398
Hollow Chop
Contouring Pliers



EI-5395
Tweed loop
Forming Pliers



EI-5399
Lingual Arch
Forming Pliers

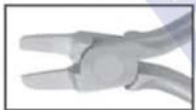

EI-5396
Arch Bending Pliers



EI-5400
Rectangular Arch
Bending Pliers

ORTHODONTICS PLIERS STANDS

- Ортодонтия Щипцы Подставки
- Supports de pinces d'orthodontie
- Kieferorthopädie Zangenständer
- Ортодонтия Щипці Підставки
- KFO Zangen Ständer
- تقويم الاسنان كماشة تقف

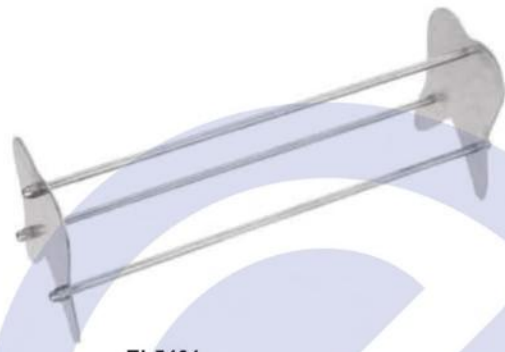

EI-5401
Plier Stand
Stainless Steel.



EI-5402
Plier Stand
Stainless Steel.



EI-5403
Pliers Stand
Stainless Rod
(Aluminum Anodized)
Stainless Steel



EI-5404
Plier Stand
Stainless Steel.



EI-5405
Plier Stand
Stainless Steel.



EI-5406
Plier Stand
Plastic

Normal Anatomy – Dental Implants

Bone Level Normal
(No Bone Loss)

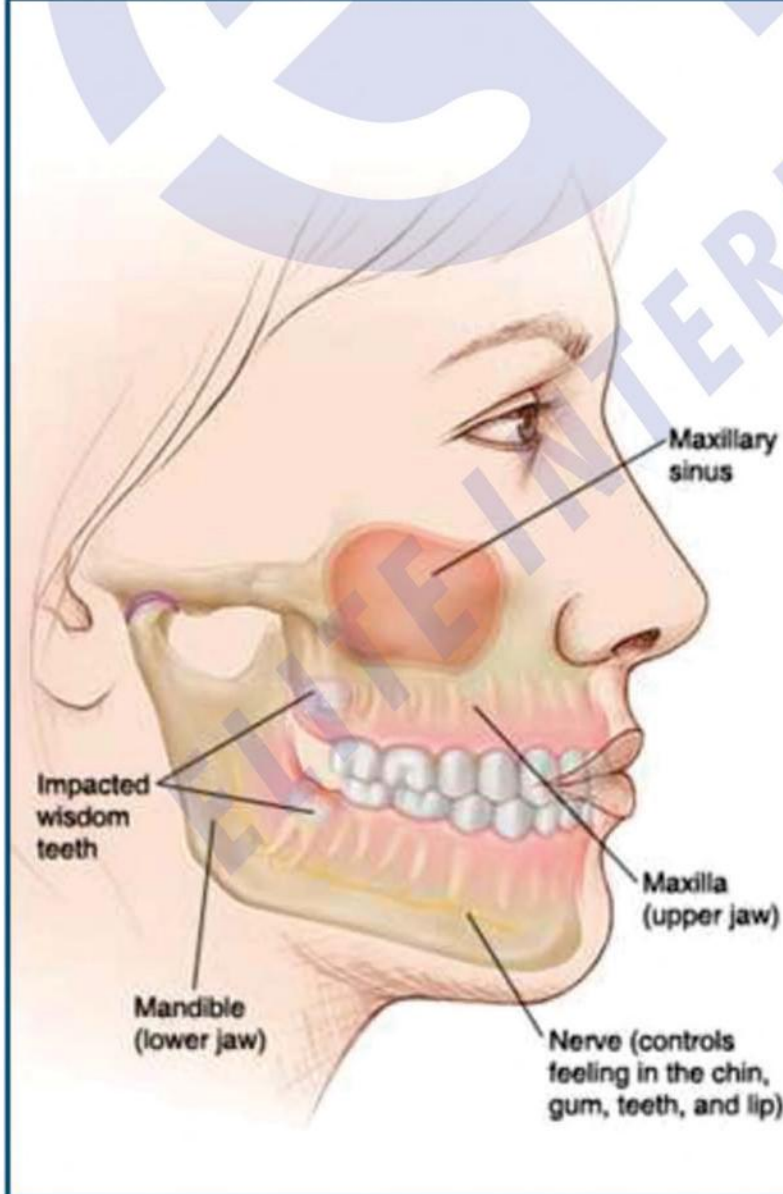
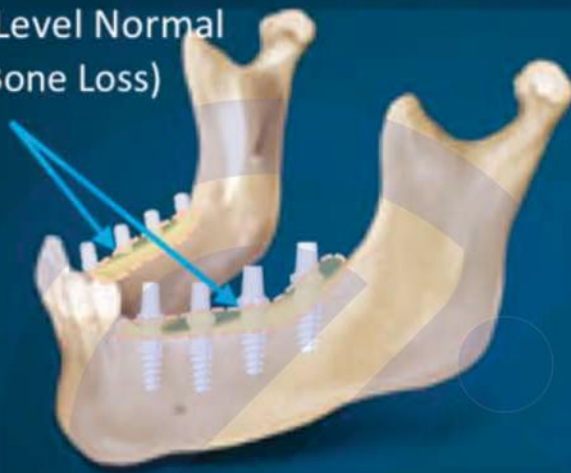

IMPLANTOLOGY

- Инструменты для имплантологии
 - Implantologie
 - Implantologie
- Інструменти для імплантології
 - Implantologia
 - زراعة الأسنان

IMPLANT GAGES



EI-5407
Multifunctional Meter
 Length 90 mm,
 different sizes,
 8-10-11mm,
 corrosion-resistant

EI-5408
Multifunctional Meter
 Length 90 mm,
 different sizes,
 5-13-15-17 mm,
 corrosion-resistant

EI-5409
Measuring Probe
 Length 170 mm,
 hand shape or flexible
 (6-8-10-14-16 mm),
 corrosion-resistant

EI-5410

EI-5411

EI-5412

EI-5413

IMPLANT GAGES



EI-5414

EI-5415

EI-5416

IMPLANTOLOGY

- Инструменты для имплантологии
- Implantologie
- Implantologie
- Инструменти для імплантології
- Implantoloia
- زراعة الأسنان



EI-5417
Ridge Mapping
Double Caliper



EI-5418
Bone Thickness Gauge
40mm, 180mm



EI-5419
Osteometer
Measuring Forceps For Jaw
Ridge Width measurement, scale
on both sides, rustfree, autoclaviv

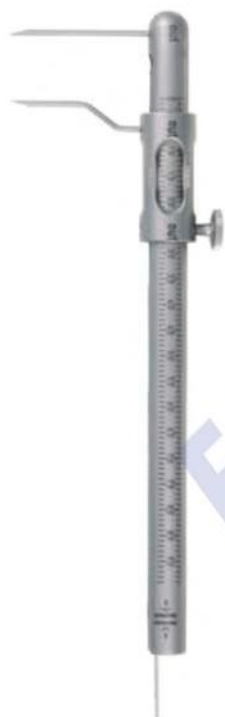

EI-5420
Micro Boley
Gauge Twisted



EI-5421
Micro Boley
Gauge Straight



EI-5422
Ortho Ruler / Cone Socket

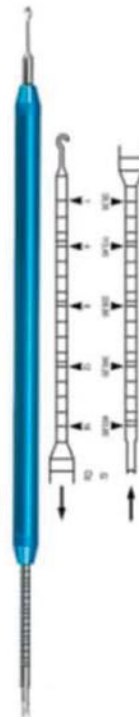

EI-5423
Dynamometer

IMPLANTOLOGY

- Инструменты для имплантологии
- Implantologie
- Implantologie
- Инструменти для імплантології
- Implantologia
- زراعة الأسنان

BLACK TITANIUM COLOUR COATED INSTRUMENTS

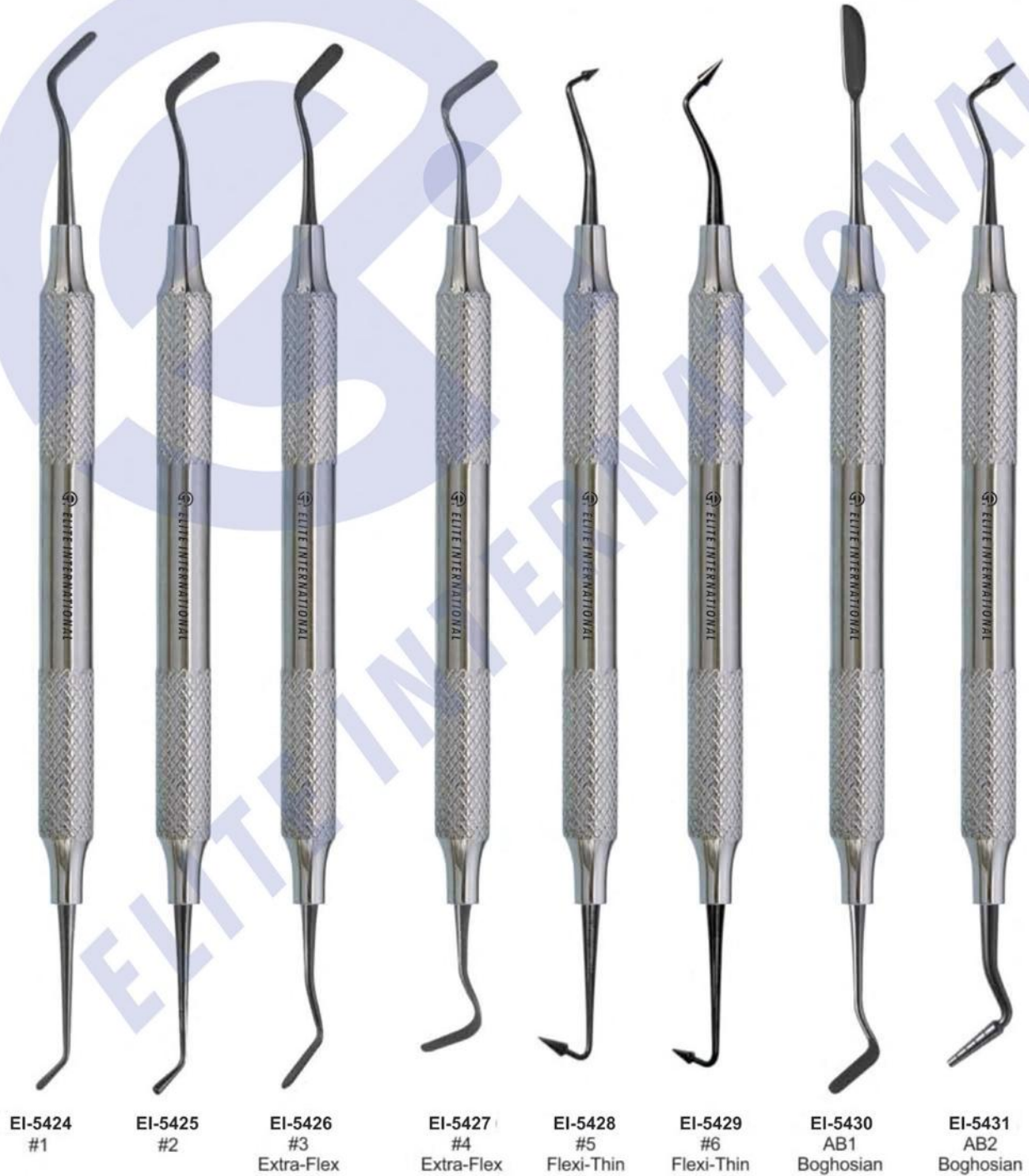

IMPLANTOLOGY

- Инструменты для имплантологии
 - Implantologie
 - Implantologie
- Инструменти для імплантології
 - Implantoloia
 - زراعة الاسنان

BLACK TITANIUM COLOUR COATED INSTRUMENTS



EI-5432
A
Cosmetic
Contouring

EI-5433
B
Cosmetic
Contouring

EI-5434
C
Cosmetic
Contouring

EI-5435
D
Cosmetic
Contouring

EI-5436
F
Cosmetic
Contouring

EI-5437
Marginal Ridge
& Embrasure
Shaping Instrument

EI-5438
Occlusal
Anatomy
Instrument

IMPLANTOLOGY

- Инструменты для имплантологии
- Implantologie
- Implantologie
- Инструменти для імплантології
- Implantologia
- زراعة الأسنان

BLACK TITANIUM COLOUR COATED INSTRUMENTS

BURNISHERS

FREEDMAN BURNISHERS

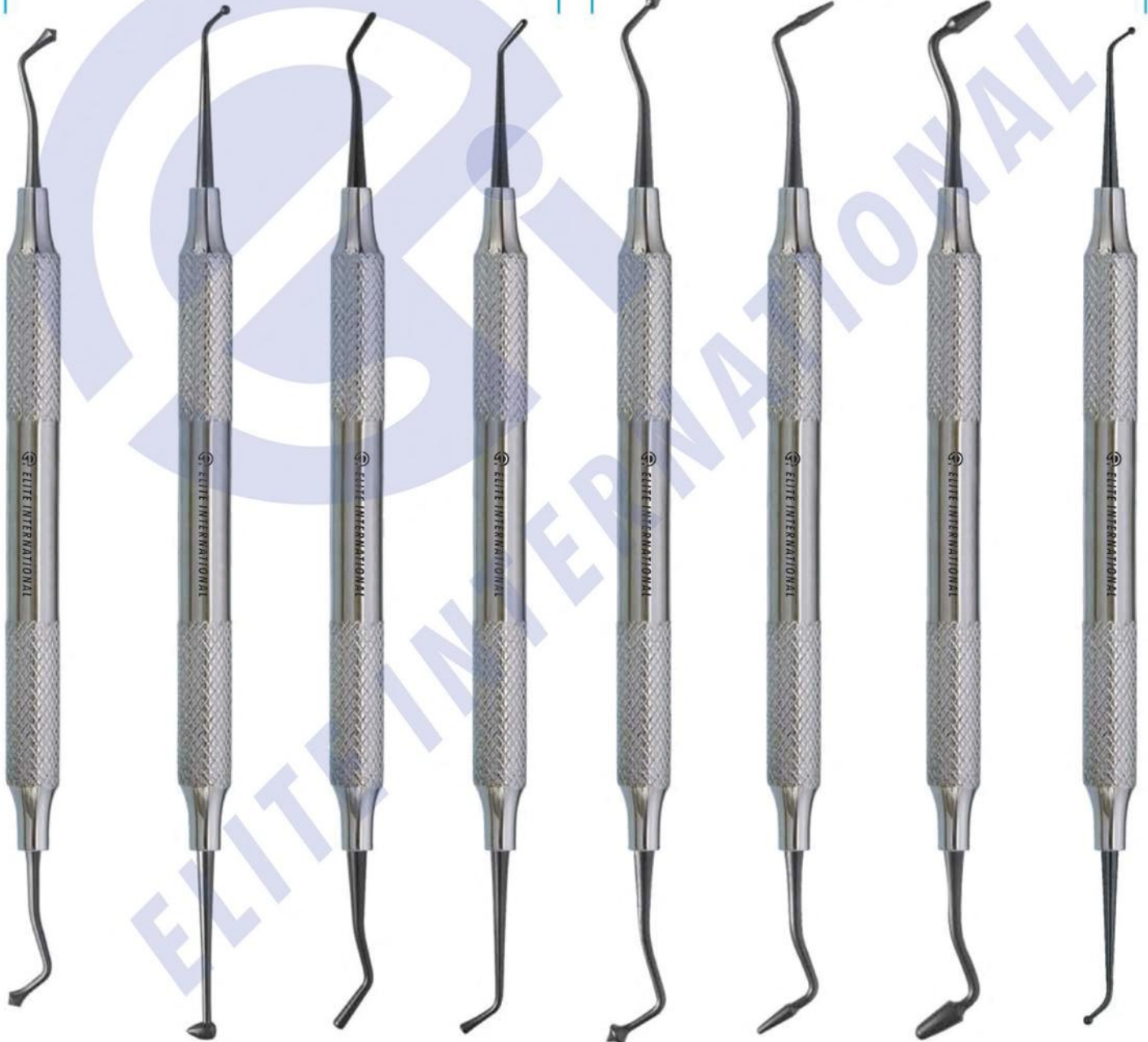

EI-5439
21B

EI-5440
27/29

EI-5441
2
Ladmore

EI-5442
3
Ladmore

EI-5443
Freedman
"Duckhead"

EI-5444
Freedman
Small Contact
Forming

EI-5445
Freedman
Large Contact
Forming

EI-5446
Small/
Medium Ball
Burnisher

IMPLANTOLOGY

- Инструменты для имплантологии
 - Implantologie
 - Implantologie
- Інструменти для імплантології
 - Implantoloia
 - زراعة الأسنان

SINUS LIFT INSTRUMENTS HOLLOW HANDLE 9.5MM LENGTH 170MM

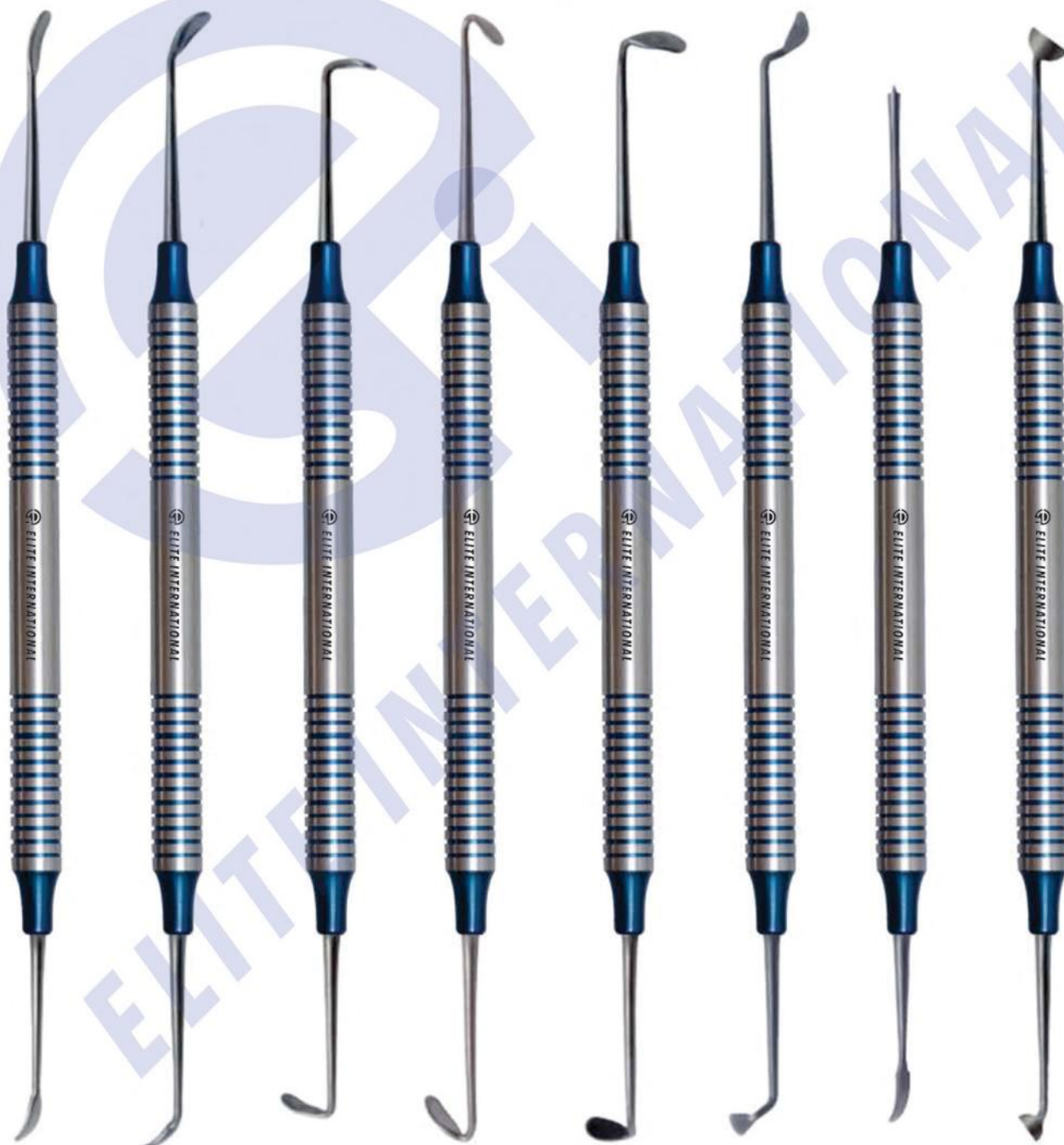

EI-5447
Sinuslift 1

EI-5448
Sinuslift 2

EI-5449
Sinuslift 3

EI-5450
Sinuslift 4

EI-5451
Sinuslift 5

EI-5452
Sinuslift 6

EI-5453
Membrane
3Positioning 1

EI-5454
Condenser 1

IMPLANTOLOGY

- Инструменты для имплантологии
- Implantologie
- Implantologie
- Инструменти для имплантології
- Implantologia
- زراعة الأسنان

Sinus Lift Instrument,
Flexible Sinus Lift instruments
reduce the risk of perforation of the
"Schneider's membrane"

Sinus Lift Elevator,
10 mm Straight grip
Length 175 mm, Sinus lift elevators, dull,
for gentle peeling and lifting the
Schneider membrane

Sinus lift instrument
10 mm Straight grip Length 180 mm,
Buser (B1, B2, B3) raspatories,
quality medical stainless steel,
corrosion-resistant

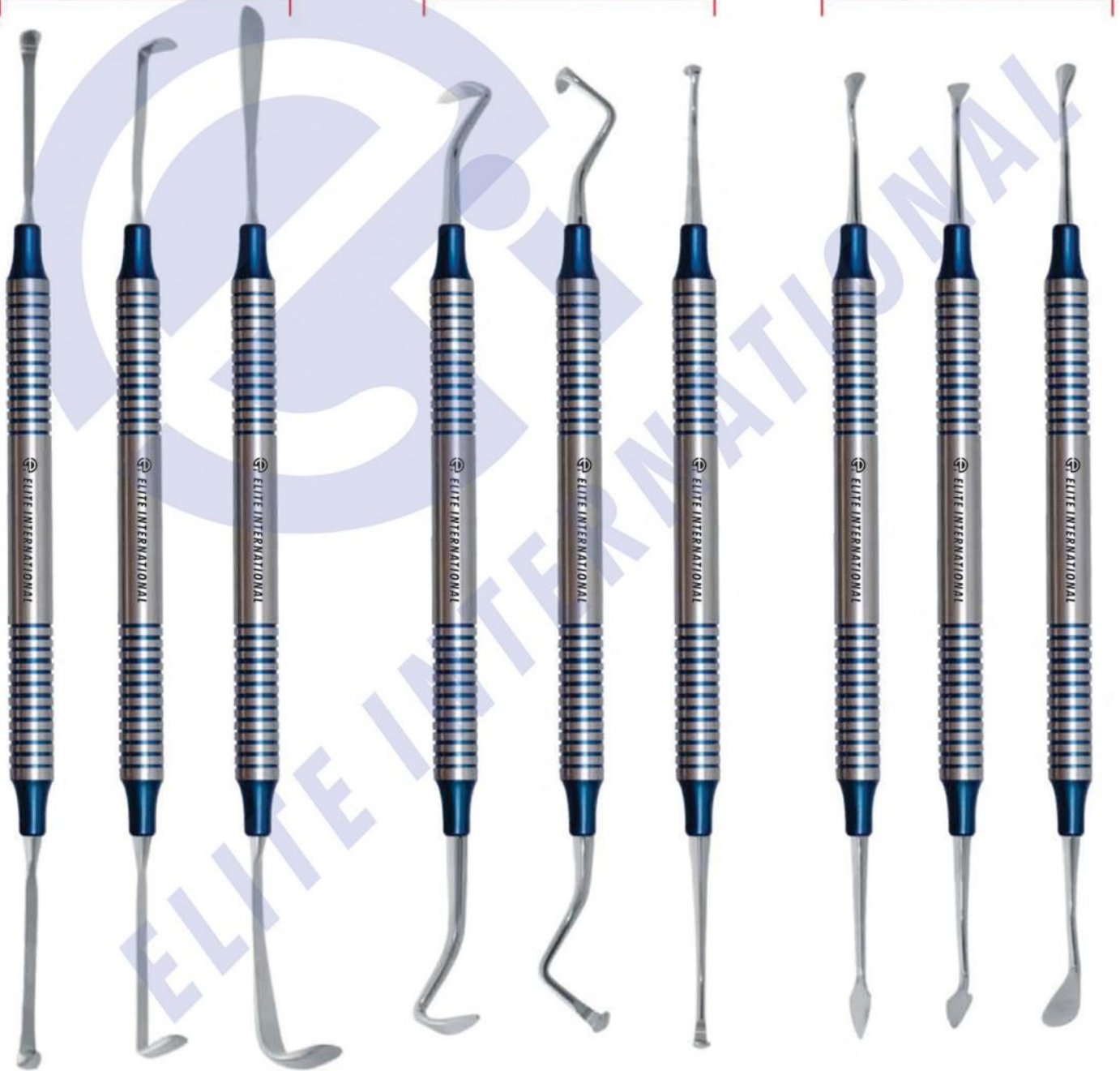

EI-5455
Fig. 1

EI-5456
Fig. 2

EI-5457
Fig. 3

EI-5458
Fig. 1

EI-5459
Fig. 2

EI-5460
Fig. 3

EI-5461
B01

EI-5462
B02

EI-5463
B03

IMPLANTOLOGY

- Инструменты для имплантологии
- Implantologie
- Implantologie
- Инструменти для імплантології
- Implantoloia
- زراعة الأسنان

Sinus lift instrument 10 mm Straight grip Sinus lift elevators, blunt or sharply curved (H01, H02, K03, K04, K78, K77)

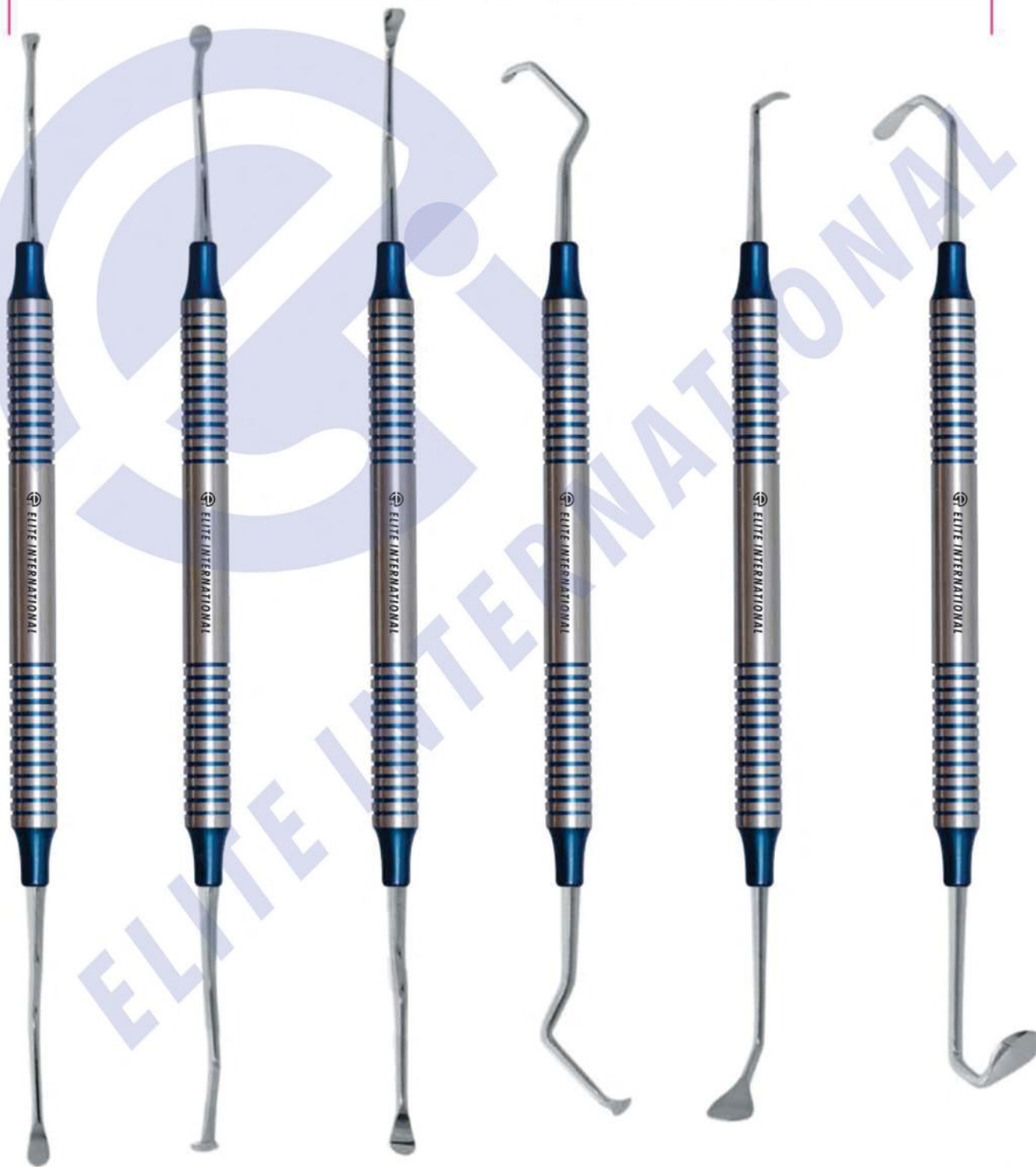

EI-5464
Sinus lift
instrument
H01

EI-5465
Sinus lift
instrument
H02

EI-5466
Sinus lift
instrument
K03

EI-5467
Sinus lift
instrument
K04

EI-5468
Sinus lift
instrument
K78

EI-5469
Sinus lift
instrument
K77

IMPLANTOLOGY

- Инструменты для имплантологии
 - Implantologie
 - Implantologie
- Инструменти для імплантології
 - Implantoloia
 - زراعة الأسنان

Composite Filling Instruments Set of 6 Pcs



EI-5470



EI-5471



EI-5472



EI-5473



EI-5474



EI-5475

COMPOSITE INSTRUMENTS USE:

A composite (tooth colored) filling is used to repair a tooth that is affected by decay, cracks, fractures, etc. The decayed or affected portion of the tooth will be removed and then filled with a composite filling.

There are many types of filling materials available, each with their own advantages and disadvantages. You and your dentist can discuss the best options for restoring your teeth. Composite fillings, along with silver amalgam fillings, are the most widely used today. Because composite fillings are tooth colored, they can be closely matched to the color of existing teeth, and are more aesthetically suited for use in front teeth or the more visible areas of the teeth.

As with most dental restorations, composite fillings are not permanent and may someday have to be replaced. They are very durable, and will last many years, giving you a long lasting, beautiful smile.

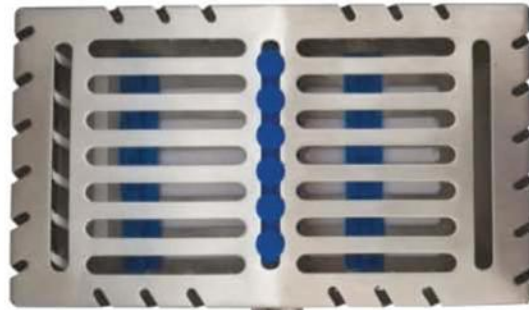

EI-5476

IMPLANTOLOGY

- Инструменты для имплантологии
- Implantologie
- Implantologie
- Инструменти для імплантології
- Implantoloia
- زراعة الأسنان

Set of 5 Composite Gold Tip Instruments
EI-5477



Set of 4 Composite Blue Tip Instruments
EI-5478



Set of 3 Composite Blue Tip Instruments
EI-5479



Set of 2 Composite Blue Tip Instruments
EI-5480



EI-5481 Periosteal Elevators Molt # 9

EI-5482 Endodontic explorer DG # 16

IMPLANTOLOGY

- Инструменты для имплантологии
- Implantologie
- Implantologie
- Инструменти для імплантології
- Implantologia
- زراعة الأسنان

VISTA TUNNELING INSTRUMENTS SET



EI-5483



EI-5484



EI-5485



EI-5486



EI-5487



EI-5488



EI-5489



IMPLANTOLOGY

- Инструменты для имплантологии
 - Implantologie
 - Implantologie
- Інструменти для імплантології
 - Implantoloia
 - زراعة الاسنان



EI-5490
used for elevation of sinus membrane



EI-5491
used for elevation of sinus membrane

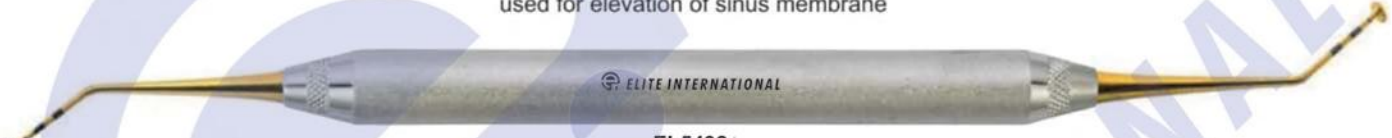

EI-5492
Cobra in / out (2-4-5-6-8-10mm)



EI-5493
Cobra 3.5mm



EI-5494
sinus 4.8 / 5.8 (2-4-5-6-8-10mm)



EI-5495
sinus 2.8 / 3.8 (2-4-5-6-8-10mm)



EI-5496
Bone Graft 3.8SP / 2.8mm (2-4-5-6-8-10mm)



EI-5497
Cobra in / out (2-4-5-6-8-10mm)



EI-5498
Cobra 3.5mm



EI-5499
Gold Color Set Dental Oral Implantology Sinus Set of 10 Pcs with cassette

IMPLANTOLOGY

- Инструменты для имплантологии
- Implantologie
- Implantologie
- Инструменти для імплантології
- Implantoloia
- زراعة الأسنان



ELITE INTERNATIONAL

EI-5500
Sinus Lift elevator 1



ELITE INTERNATIONAL

EI-5501
Sinus Lift elevator 2



ELITE INTERNATIONAL

EI-5502
Sinus Lift elevator 3



ELITE INTERNATIONAL

EI-5503
Sinus Lift elevator 4



ELITE INTERNATIONAL

EI-5504
Sinus Lift elevator 5



ELITE INTERNATIONAL

EI-5505
Sinus Lift elevator 6



EI-5506
Sinus Lift Elevators Set of 7 Pcs
with cassette

IMPLANTOLOGY

- Инструменты для имплантологии
- Implantologie
- Implantologia
- زراعة الأسنان

Sinus Left Elevator Set of 10 Pcs

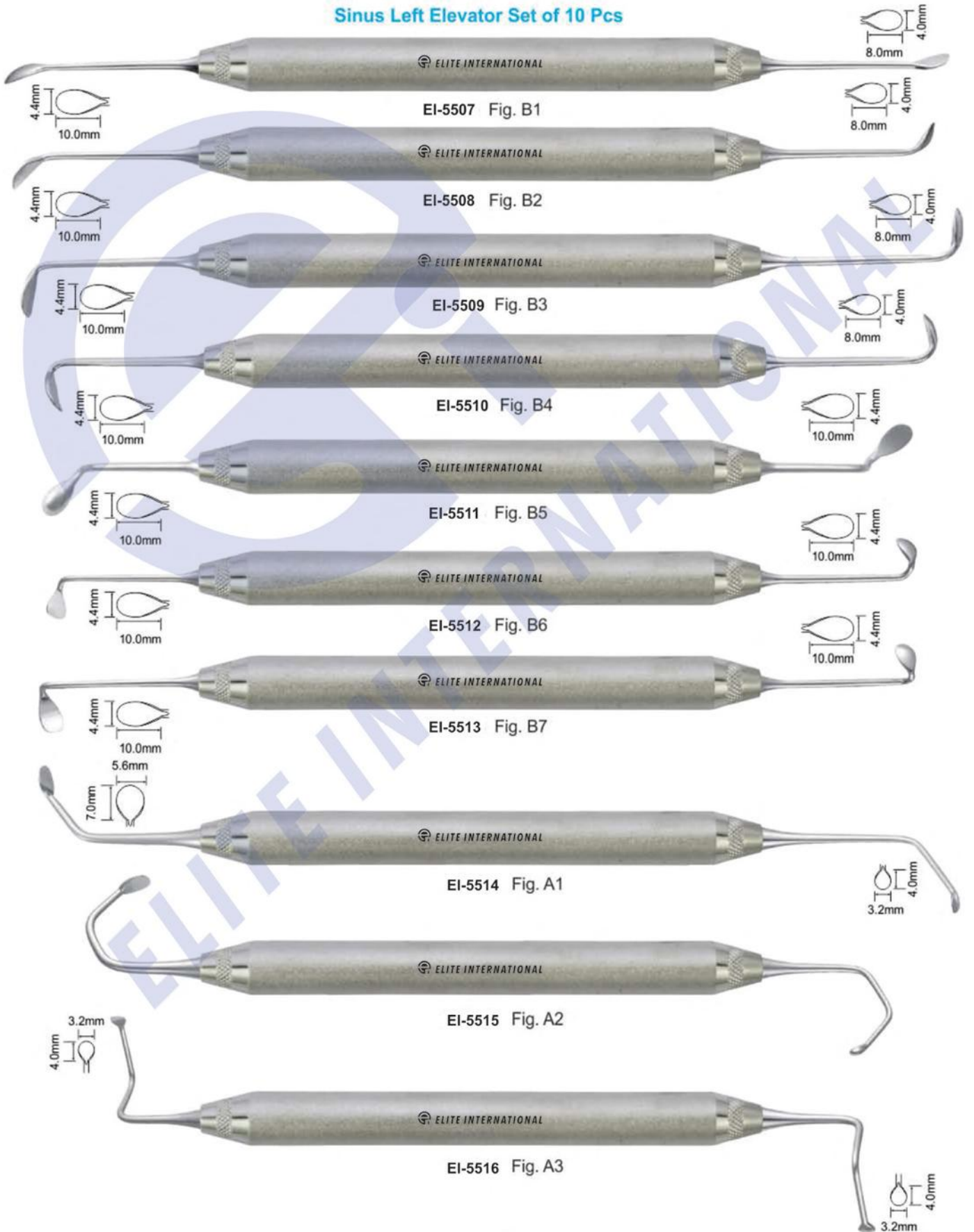

IMPLANTOLOGY

- Инструменты для имплантологии
- Implantologie
- Implantologie
- Инструменти для імплантології
- Implantologia
- زراعة الأسنان

Blue Titanium Coated Bone Grafting Instruments



EI-5517

Bone Graft 1.0 / 1.7 mm Titanium 8. 11. 13. 15. 18 mm



EI-5518

Bone Graft 1.0 / 2.0 mm Titanium 8. 11. 13. 15. 18 mm



EI-5519

Bone Graft 2.4 / 2.7 mm Titanium 8. 11. 13. 15. 18 mm



EI-5520

Bone Graft 3.3 / 4.0 mm Titanium 8. 11. 13. 15. 18 mm



EI-5521

Bone Graft 3.3 / 4.0 mm Titanium Coated Tips



EI-5522

Bone Graft / Carrier Titanium 8. 11. 13. 15. 18 mm

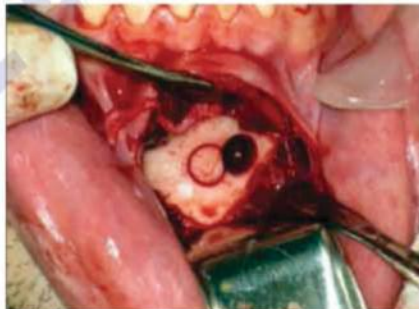

EI-5523

Blue Titanium Coated Bone Grafting Instruments Set of 7 Pcs with cassette

- Инструменты для имплантологии
- Implantologie
- Implantologie

- Инструменти для имплантології
- Implantologia
- زراعة الأسنان

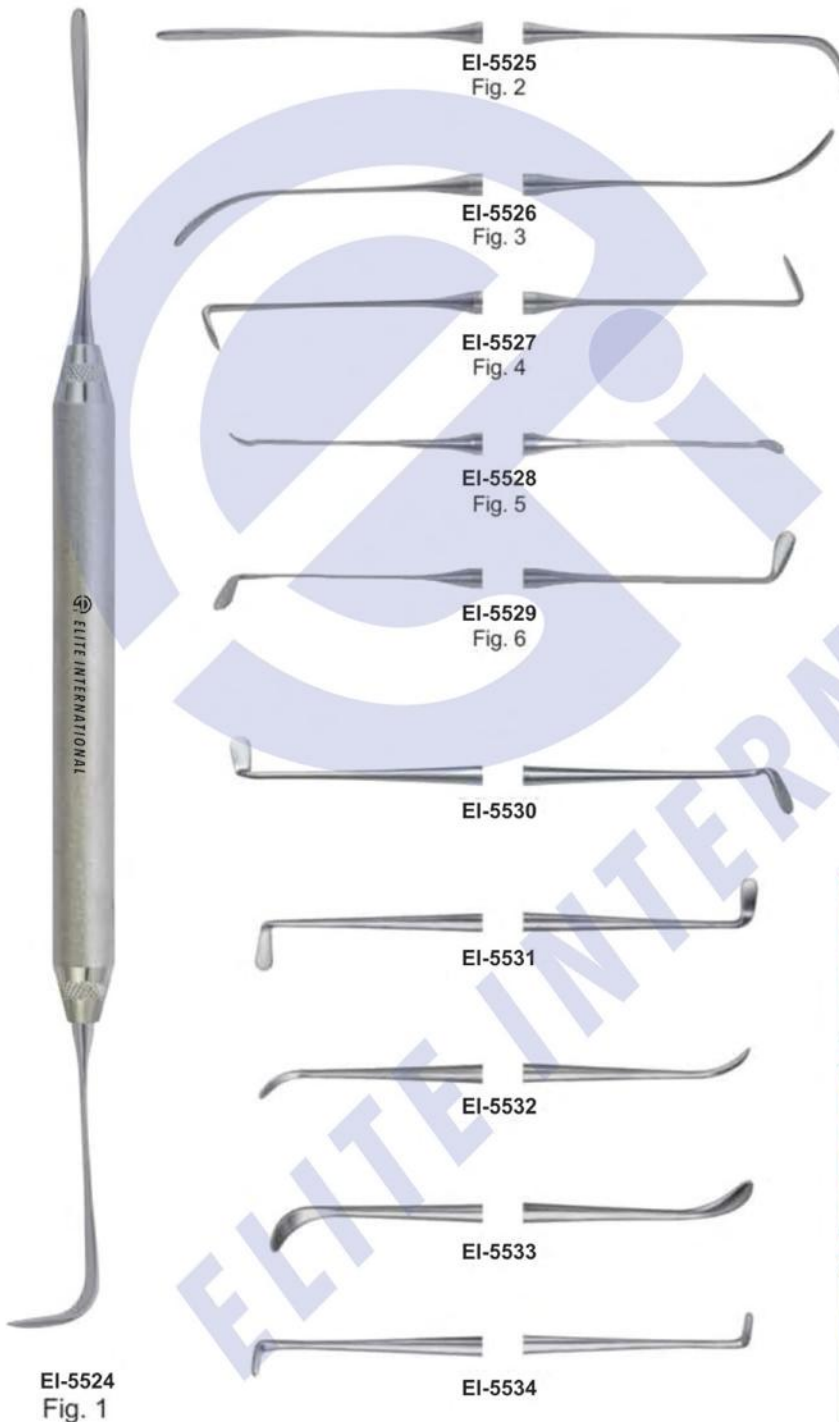

With curette the sinus membrane is further detached over a broad area in the inner region, especially along the roof of the palate.

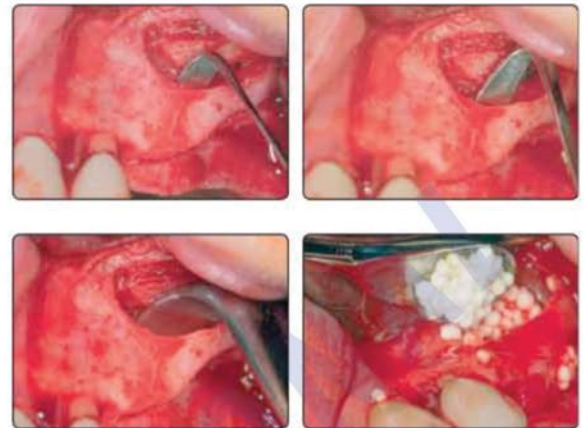

Flexible Sinus-Lift Curettes – for an optimum sensitivity during the direct lift procedure

The perforation of the Schneiderian membrane is a complication that often occurs during a maxillary sinus floor augmentation procedure. The Sinus-Lift Instruments increase the sensitivity by blunt and flexible working tips with "Swing-Effect". Because of their special shapes and the characteristic of the stainless steel between the handle and the active part, light pressure is cushioned and gives the operator a direct and sensitive response. At the same time the risk to perforate the Schneiderian membrane is reduced to a minimum. Already at the development the focus was a practicable handling. Because of varying angulations and shapes of the active parts also in difficult areas they are easy to navigate also in difficult areas. The line of curettes consists of six different figures for every situation. They are complemented by spoon and condenser to place the bone graft.



The "Schneider's Membrane" of the sinus can be detached with curette by 1–2mm along the total cortical bone.



Curette is particularly useful in the lower part for detaching the membrane further. The same goes for the caudal area, especially when the membrane is 4–5 mm above the base of the maxillary sinus and the maxillary sinus is built up with granular material.



Curette makes it possible to lift the membrane further in mesial region. One working tip is especially designed for the right maxillary sinus and the other for the left maxillary sinus.



With curette the sinus membrane is further elevated in the upper and posterior part of the maxillary sinus wall.

IMPLANTOLOGY

- Инструменты для имплантологии
- Implantologie
- Implantologie
- Инструменти для имплантології
- Implantologia
- زراعة الأسنان

IMPLANT SINUS LIFT INSTRUMENTS HOLLOW HANDLE 9.5MM LENGTH 170MM

SINUS LIFT INSTRUMENTS HOLLOW HANDLE 9.5MM LENGTH 170MM



EI-5536
Sinus1

EI-5537
Sinus2

EI-5538
Sinus
Obtuse 6...

EI-5539
Sinus 4

EI-5540
Sinus 5

EI-5541
Sinus 6

EI-5542
Sinus 7

EI-5535
Acute 6577



EI-5545
Sinuslift 2

EI-5546
Sinuslift 3

EI-5547
Sinuslift 4

EI-5548
Sinus1

EI-5549
Sinus1

EI-5550
Membrane
3Positioning 1

EI-5551
Condenser 1

EI-5544
Sinuslift 1



9 Pcs of Set
EI-5543



9 Pcs of Set
EI-5552

IMPLANTOLOGY

- Инструменты для имплантологии
- Implantologie
- Implantologie
- Инструменти для імплантології
- Implantoloia
- زراعة الأسنان

IMPLANT SINUS LIFT INSTRUMENTS
 PERIODONTAL SURGERY SURGICAL CHISELS
 KRAMER NEVINS SINUS LIFT

SURGICAL CHISELS



EI-5553
TG



EI-5554 SOLT3/4



EI-5555 TGO



EI-5556 OCH3



EI-5557 OCH4



EI-5558 FEDI1



EI-5559 FEDI2



EI-5560 FEDI3



EI-5561 13K/TG



EI-5562
13K/TG Titanium



EI-5563 13K/TG



EI-5564
13KL/R Titanium



EI-5565 13KL 4/6mm
Titanium Available



EI-5566
Cassette For Instruments

IMPLANTOLOGY

- Инструменты для имплантологии
- Implantologie
- Implantologie
- Инструменти для імплантології
- Implantologia
- زراعة الأسنان

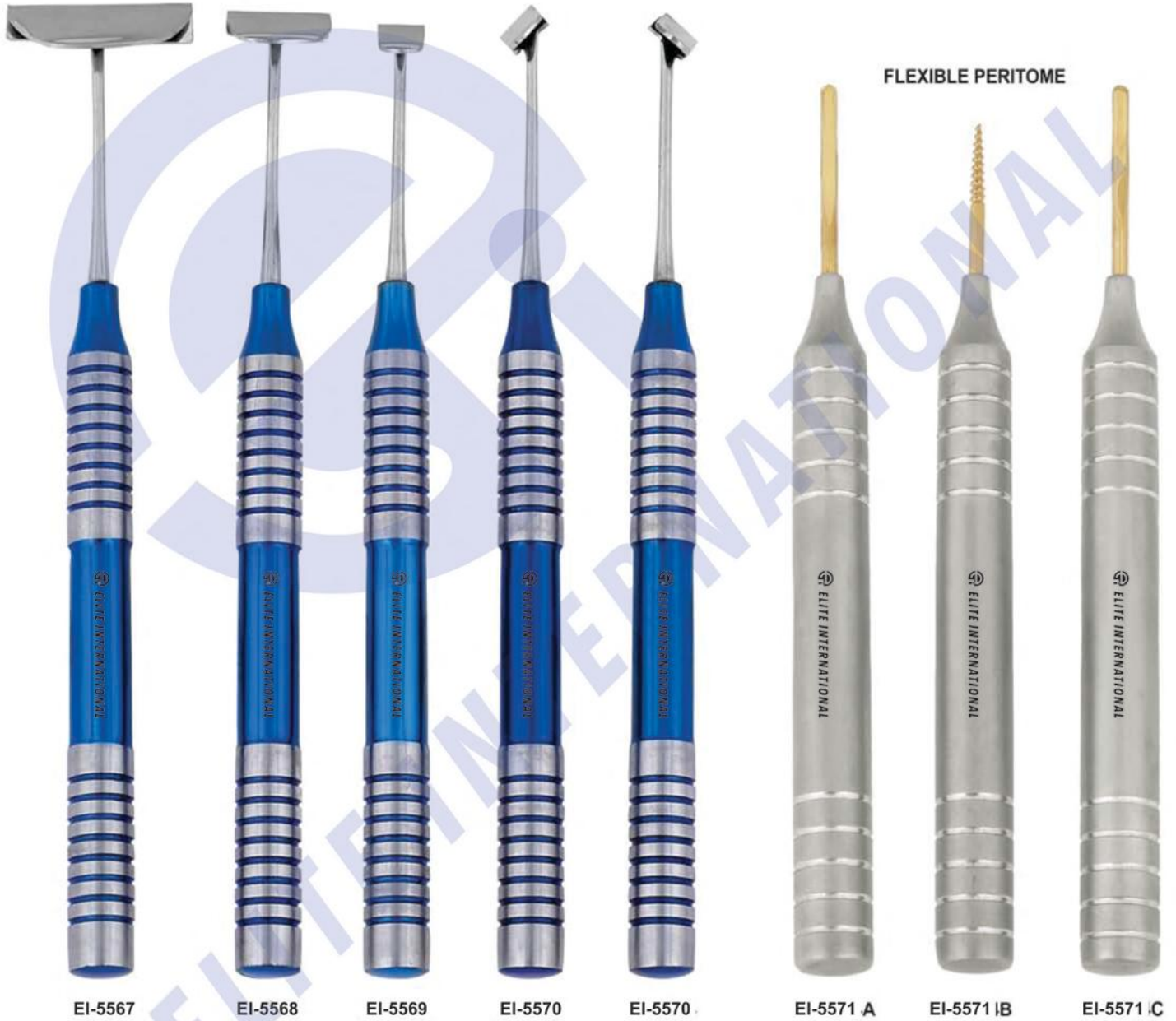

EI-5567

EI-5568

EI-5569

EI-5570

EI-5570

EI-5571 A

EI-5571 IB

EI-5571 C

Soft Brushing Kit Set of 6 Pcs



IMPLANTOLOGY

- Инструменты для имплантологии
- Implantologie
- Implantologie
- Инструменти для імплантології
- Implantologia
- زراعة الأسنان

SINUS ELEVATOR & MEMBRANE LIFT TIPS



EI-5572
Membrane Detach Elevator



EI-5573
Membrane Elevator



EI-5574
Membrane Elevator



EI-5575
Membrane Elevator



EI-5576
Membrane Elevator



EI-5577
Bone Graft Packer



EI-5578 A Pt2 Titanium
A/V Regular



EI-5578 B Pt1 Titanium
A/V Regular



EI-5578 C Pt3 Titanium Angel S/E



EI-5578 D Pt4 Titanium STR S/E



EI-5578 E Pt5 Titanium TG CVD S/E



EI-5579
Sinus Left Elevator & Membrane Lift Tips 3
set of 7 Pcs

IMPLANTOLOGY

- Инструменты для имплантологии
- Implantologie
- Implantologie
- Инструменти для імплантології
- Implantologia
- زراعة الأسنان

MIXING SPATULA WITH SHOVEL



EI-5580
Bone Carrier
Titanium



EI-5581
Raspator, Prichard
Length 180 mm,
10 mm hollow handle,
double-ended
10.5 mm | 4.5 mm,



EI-5582
Raspator, Prichard
Length 180 mm,
10 mm hollow handle,
double ended



EI-5583
Raspator, Prichard
Length 180 mm,
10 mm hollow handle,
double-ended
10.5 mm | 4.5 mm,



EI-5584
Mixing Spatula
with shovel
17cm



EI-5585
Mixing Spatula
with shovel
18.5cm



EI-5586
Graft Material Spoon
Concave Tip For
Larger Grafts

IMPLANTOLOGY

- Инструменты для имплантологии
 - Implantologie
 - Implantologie
- Инструменти для імплантології
 - Implantoloia
 - زراعة الاسنان

BONE GRAFTING INSTRUMENTS COMPACTOR /TAMPERS

Product offering includes instruments for harvesting, mixing and compacting bone Provides clinicians with the proper instrumentation for bone grafting procedures Weighted bone basin Prevents tipping and spilling of bone and other materials during mixing



EI-5587
Graft Packer, Concave Tips DE 4/6mm



EI-5588
Bone Spoon/ Packer DE 3mm



EI-5589
Blade and pusher Length 180 mm, for straight or angled, blade: 15 x 5 mm, pusher: 4 mm diameter Straight



EI-5590
Blade and pusher Length 180 mm, for straight or angled, blade: 15 x 5 mm, pusher: 4 mm diameter angular



EI-5591
Spoon and pusher Length 180 mm, for angled spoon: 10 x 5 mm, pusher: diameter 3 mm



EI-5592
Graft Packer, Smooth Tips DE 5/8mm



EI-5593
Graft Packer, Serrated Tips DE 3/4mm



EI-5594
Graft Packer, Serrated Tips DE 6/8mm



EI-5595
Titanium graft packer/ placement site depth gauge 3.3mm & 4.0mm Diameter tips Marked at 8, 11, 13, 15 & 18mm



EI-5596
Tamper Length 170 mm, for bone material, double-ended, diameter 3.2 mm (2-4-6-8-10) and diameter 2.5mm (2-4-6-8-10)

IMPLANTOLOGY

- Инструменты для имплантологии
- Implantologie
- Implantologie
- Инструменти для імплантології
- Implantologia
- زراعة الأسنان

SPOON AND PUSHER (TRINOVO)

Trinovo handle, different workers, for bone material, high-grade medical stainless steel, corrosion-resistant



IMPLANTOLOGY

- Инструменты для имплантологии
 - Implantologie
 - Implantologie
- Інструменти для імплантології
 - Implantoloia
 - زراعة الاسنان

Hollow Handle 10mm Length 170mm

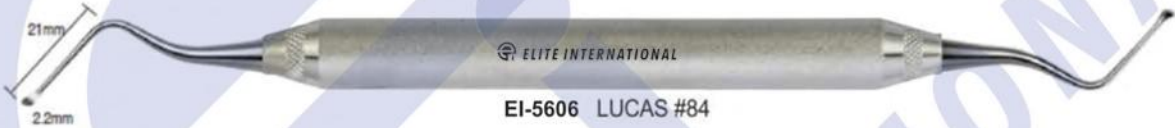

IMPLANTOLOGY

- Инструменты для имплантологии
- Implantologie
- Implantologie
- Инструменти для імплантології
- Implantoloia
- زراعة الأسنان

TISSUE MEMBRANE FORCEPS



EI-5613
Tissue Graft Forcep
Serrated Teeth

EI-5614
Self Locking
Grooved

EI-5615
Tissue Graft Forcep
Serrated Teeth

EI-5616
Titanium
Locking Plier

EI-5617
TC Gripper Carbide
Tipped Tissue Forceps
Serrated Carbide Tips
14.5cm

EI-5618
Adson Carbide
Tipped Tissue Forceps
Serrated Carbide Tips
12cm



EI-5619
Micor Adson 1x2
Tissue Forcep 12.1cm
1x2 Teeth - 0.5mm Tips

EI-5620
Adson 7x7
Tissue Forceps
7x7 Teeth 12cm

EI-5621
Adson 7x7 Curved
Tissue Forceps
7x7 Teeth 12cm

EI-5622
Suture Pliers
Suture Forceps with
1.6mm Ring Tip

EI-5623
Debakey Atraumatic
Tissue Forceps Straight
Serrated Teeth
16cm

EI-5624
Debakey Atraumatic
Tissue Forceps Curved
Serrated Teeth
16cm

IMPLANTOLOGY

- Инструменты для имплантологии
 - Implantologie
 - Implantologie
- Інструменти для імплантології
 - Implantologia
 - زراعة الأسنان

TISSUE MEMBRANE FORCEPS



EI-5625
Russian Long
Tissue Forceps
Serrated Tip
20cm



EI-5626
Russian
Tissue Forceps
Serrated Tip
15cm



EI-5627
Tissue Punch Forceps
To Remove Tissue
After Using Punch



EI-5628
13.5 cm
narrow



EI-5629
10.5 cm
Membrane tweezers KUEHNE



EI-5630
13.5 cm
wide



EI-5631
Pin-Tweezers
with or without lock,
length 15 cm,
with lock



EI-5632
without lock



EI-5633
Haltepinzette with lock
15,5 cm, for pins, towards
the tips, etc



EI-5634
Carry Forceps
15cm



EI-5635
Carry Forceps
15cm



EI-5636
Carry Forceps
15cm

IMPLANTOLOGY

- Инструменты для имплантологии
- Implantologie
- Implantologie
- Инструменти для імплантології
- Implantologia
- زراعة الأسنان

OSTEOTOME CONVEXES / CONCAVE / CONIQUES

CONVEXES

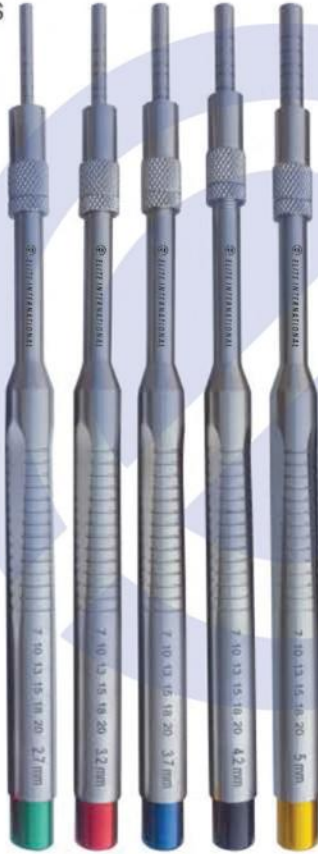

EI-5637
SET OF 5 PIECES

CONCAVES







EI-5638
SET OF 5 PIECES

CONIQUES

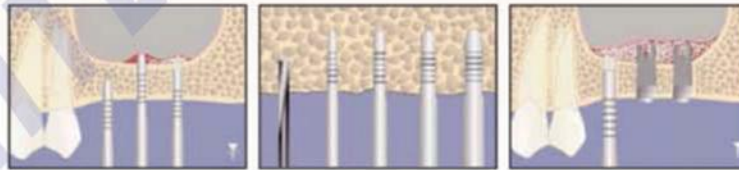

EI-5639
SET OF 5 PIECES



	CONVEXES STRAIGHT	EI-5640	2,7 Ømm	3,2 Ømm	3,7 Ømm	4,2 Ømm	5 Ømm
	CONCAVES STRAIGHT	EI-5641	2,7 Ømm	3,2 Ømm	3,7 Ømm	4,2 Ømm	5 Ømm
	CONIQUES STRAIGHT	EI-5642	2,7 Ømm	3,2 Ømm	3,7 Ømm	4,2 Ømm	5 Ømm

IMPLANTOLOGY

- Инструменты для имплантологии
- Implantologie
- Implantologie
- Инструменти для імплантології
- Implantoloia
- زراعة الأسنان

OSTEOTOME CONVEXES / CONCAVE / CONIQUES





EI-5643
SET OF 5 PIECES

EI-5644
SET OF 5 PIECES

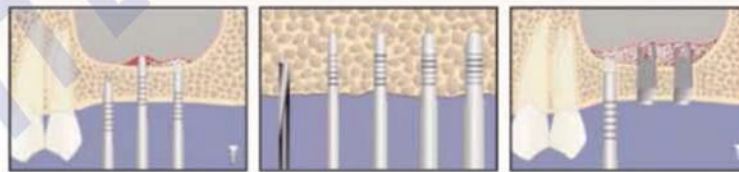
EI-5645
SET OF 5 PIECES



	CONVEXES CURVED	EI-5646	2,7 Ømm	3,2 Ømm	3,7 Ømm	4,2 Ømm	5 Ømm
	CONCAVES CURVED	EI-5647	2,7 Ømm	3,2 Ømm	3,7 Ømm	4,2 Ømm	5 Ømm
	CONIQUES CURVED	EI-5648	2,7 Ømm	3,2 Ømm	3,7 Ømm	4,2 Ømm	5 Ømm

IMPLANTOLOGY

- Инструменты для имплантологии
- Implantologie
- Implantologie
- Инструменти для імплантології
- Implantologia
- زراعة الأسنان

BONE SCRAPER STRAIGHT & CURVED



EI-5649
Bone Scraper
Straight

EI-5650
Bone Scraper
Curved

TISSUE PUNCH STRAIGHT & CURVED



Tissue Punch
Straight



Tissue Punch
Curved

●
EI-5651
2.0mm

●
EI-5653
5.0mm

●
EI-5655
7.0mm

●
EI-5652
4.0mm

●
EI-5654
6.0mm

●
EI-5656
8.0mm

●
EI-5657
2.0mm

●
EI-5659
5.0mm

●
EI-5661
7.0mm

●
EI-5658
4.0mm

●
EI-5660
6.0mm

●
EI-5662
8.0mm



EI-5663
Tissue Punch with pin
Set of Four Pieces

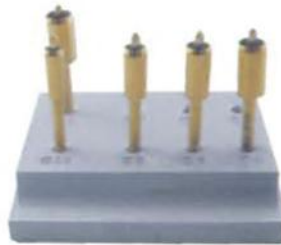

EI-5664
Tissue Punch
Set of Five Pieces



EI-5665
Tissue Punch
Set of Five Pieces

IMPLANTOLOGY

- Инструменты для имплантологии
- Implantologie
- Implants
- Инструменти для імплантології
- Implantologia
- زراعة الأسنان

BONE MILL BONE WELL

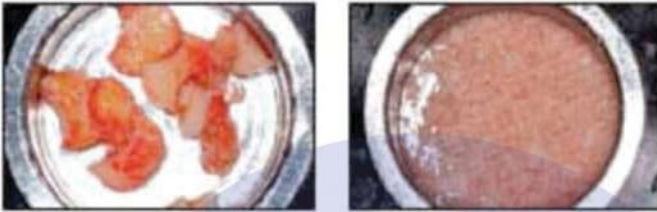

IMPLANTOLOGY

- Инструменты для имплантологии
- Implantologie
- Implantologie
- Инструменти для імплантології
- Implantologia
- زراعة الأسنان

TREPINE

Burs with depth markings are suited for precise and simple transplantation of cylindrical bone grafts as well as for all other bone-extraction tasks.



EI-5681
Trepine Drill
Set of Eight Pieces



EI-5682
Trepine Drill
Set of Eight Pieces

BONE INJECTORS, COLLECTORS & SUCTION TUBE



IMPLANTOLOGY

- Инструменты для имплантологии
 - Implantologie
 - Implantologie
- Инструменти для имплантології
 - Implantoloia
 - زراعة الأسنان

BONE EXPANDER SCREW & SURGICAL KITS



Ø2.0mm Ø2.5mm Ø2.8mm
EI-5691 Short Implant Drills

Ø3.2mm Ø3.65mm Ø4.2mm Ø5.2mm
EI-5692 Long Implant Drills



EI-5693
Bone Universal Kit
Drill: 2mm, 2.8mm, 3.2mm, 3.65mm, 4.2mm, 4.5mm, 4.8mm, 5.2mm
Trepines Bit: 3.0mm, 4.0mm, 5.0mm, 6.0mm, 7.0mm, 8.0mm, 9.0mm, 10mm.
Driver: 2.5mm, 2.5mm Hand Pcs, 1.25mm, 1.25mm Hand Pcs
Short Driver 2.5mm, Long Driver 2.5mm
1.25mm, Short Hex Driver Hand Pcs
1.25mm, Long Hex Driver Hand Pcs, Torque Wrench 4.0mm



EI-5694
Bone Expander Kit
Expander: 2.6mm, 3.0mm, 3.4mm, 3.8mm, 4.3mm
Ratchet Driver, Parallel Pin
Pilot Drill, Drill 1.4mm, Drill Driver 4mm
Hand Driver 4mm, Ratchet 4.0mm



EI-5695
Bone Universal Kit
Drill: 2mm, 2.8mm, 3.2mm, 3.65mm, 4.2mm, 4.5mm, 4.8mm, 5.2mm
Trepines Bit: 3.0mm, 4.0mm, 5.0mm, 6.0mm, 7.0mm, 8.0mm, 9.0mm, 10mm.

Bone Compression: 2mm, 3.3mm, 2.8mm, 4.2mm, 3mm, 3.5mm
Driver: 2.5mm, 2.5mm Hand Pcs
1.25mm, 1.25mm Hand Pcs
Short Driver 2.5mm
Long Driver 2.5mm
1.25mm, Short Hex Driver Hand Pcs
1.25mm, Long Hex Driver Hand Pcs
Torque Wrench 6.35mm 1 Pcs



EI-5696
Conical Drills: 20 Pcs
Tissue Punches: 3.0mm, 3.50mm, 4.0mm, 4.5mm, 5.0mm, 6.0mm, 6.50mm
Bone Expander: 1.6/3.8mm, 1.9/3.0mm, 2.1/3.6mm, 2.6/3.8mm, 2.9/4.3mm
Drill Adapter: 1 Pcs
1.25mm, 2.50mm Hex Driver Hand Pcs

Pilot Drill: 1.6mm
Drill Bit: 1.4mm, 1.6mm, 1.8mm, 2.0mm, 2.2mm
Ratchet Driver: 4mm/6.35, 1.25/2.50
Rimer: 3.2/4.7mm, 3.7/4.7mm
Parallel Pin: 4.5mm, 2.5mm
Double step Drill: 2.4/2.8mm
Depth Gauge: 1 Pcs
Torque Wrench 6.35mm Universal: 1 Pcs

IMPLANTOLOGY

- Инструменты для имплантологии
 - Implantologie
 - Implantologie
- Інструменти для імплантології
 - Implantologia
 - زراعة الأسنان

KEYS FOR IMPLANT SCREW



EI-5697

EI-5698

EI-5699

EI-5700

TORQUE WRENCH & RATCHET



EI-5701 Star Torque Wrench 6.35mm Universal

EI-5707 Star Torque Wrench 6.35mm Universal

EI-5713 Star Ratchet Wrench 6.35mm Universal

EI-5702 Round Torque Wrench 4.0mm Universal

EI-5708 Star Torque Wrench 6.35mm Universal

EI-5714 Star Ratchet Wrench 4.0mm Universal

EI-5703 Hex Driver With 4.0mm Driver

EI-5709 Star Torque Wrench 6.35mm Universal

EI-5715 Round Ratchet Wrench 4.0mm Universal

EI-5704 Star Torque Wrench 6.35mm Universal

EI-5710 Star Torque Wrench 6.35mm Universal

EI-5716 Round Ratchet Wrench 3.35mm Universal

EI-5705 Hex Torque Wrench 4.00mm Universal

EI-5711 Star Ratchet Wrench 6.35mm Universal

EI-5717 Star Ratchet Wrench 4.0mm Universal

EI-5706 Star Torque Wrench 6.35mm Universal

EI-5712 Star Ratchet Wrench 6.35mm Universal

EI-5718 Star Ratchet Wrench 6.35mm Universal

IMPLANTOLOGY

- Инструменты для имплантологии
- Implantologie
- Implantsologie
- Инструменти для імплантології
- Implantologia
- زراعة الأسنان



EI-5719
Suction Cannula Kit
with 3 Needles



Suction Pipe



Suction Needle
1mm



Suction Needle
1.5mm



Suction Needle
2mm



2cm

2.7cm

With Filter

EI-5720
17.5cm

EI-5721
18cm

EI-5722
coarse
Ø 5mm



DE-2409
fine
Ø 9mm

Suction tubes to collect
the extracted
bone material
180mm

1.5mm 3mm 5mm



EI-5723
Suction
Tubes
180mm

EI-5724
Suction
Tubes
180mm

EI-5725
Suction
Tubes
180mm



EI-5727
Ø 3 mm
length 180mm
EI-5728
Ø 4 mm
length 180mm
EI-5729
Ø 5 mm
length 180mm

EI-5726
Fig. 6FR
Frazier
15 cm - Ø 2 mm

IMPRESSION TRAYS

- Оттисные ложки
- Porte-empreinte
- Abdrucklöffel
- Відбиткові ложки
- Cubetas para impresiones
- صواني الانطباع

PERFORATED WITH RIM LOCK

Set of 06 Pcs



EI-5730 SET OF 06 PCS
Upper: S, M, L
Lower: S, M, L

PERFORATED WITH RIM LOCK

Set of 8 Pcs



EI-5731 SET OF 08 PCS
Upper: XS, S, M, L
Lower: XS, S, M, L

EI-5732 SET OF 08 PCS
Upper: S, M, L, XL
Lower: S, M, L, XL

EI-5733 SET OF 10 PCS
Upper: XS, S, M, L, XL
Lower: XS, S, M, L, XL

IMPRESSION TRAYS

- Оттисные ложки
 - Porte-empreinte
 - Abdrucklöffel
- Відбиткові ложки
 - Cubetas para impresiones
 - صواني الانطباع

SOLID WITH RIM LOCK

Set of 6 Pcs

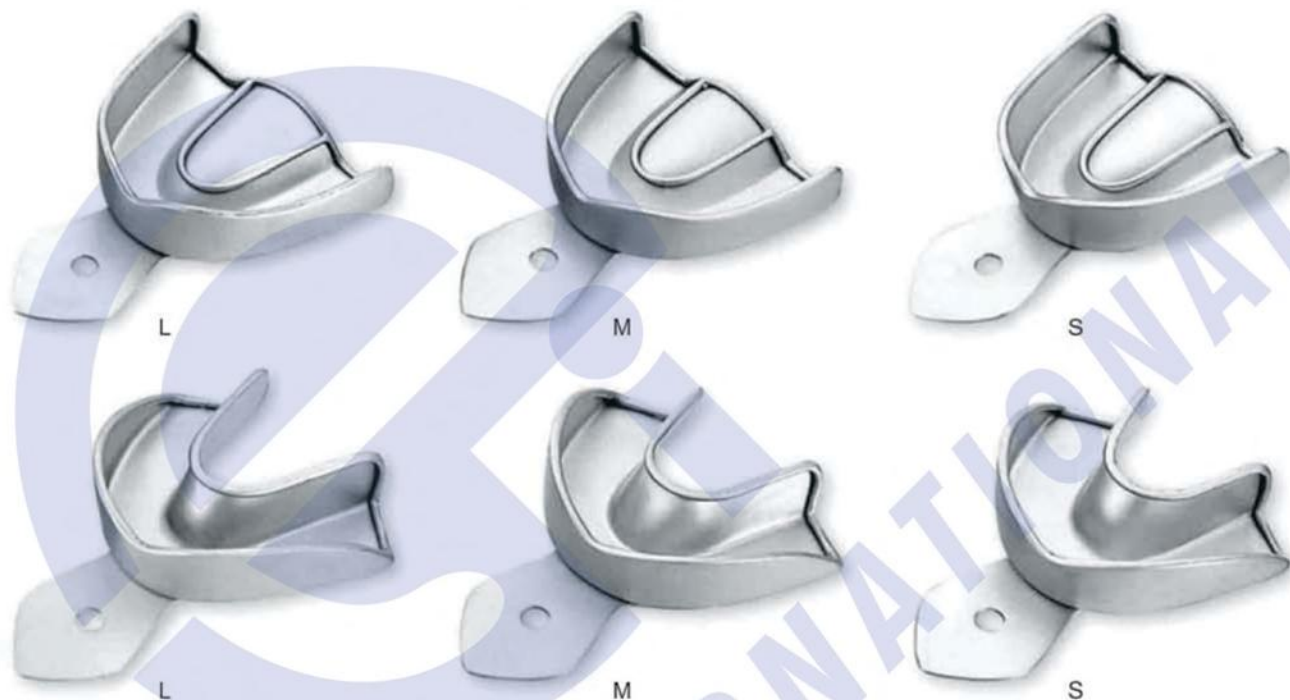

EI-5734 SET OF 06 PCS

Upper: S, M, L
Lower: S, M, L

SOLID WITH RIM LOCK

Set of 8 Pcs



EI-5735 SET OF 08 PCS

Upper: XS, S, M, L
Lower: XS, S, M, L

EI-5736 SET OF 08 PCS

Upper: S, M, L, XL
Lower: S, M, L, XL

EI-5737 SET OF 10 PCS

Upper: XS, S, M, L, XL
Lower: XS, S, M, L, XL

IMPRESSION TRAYS

- Оттисковые ложки
 - Porte-empreinte
 - Abdrucklöffel
- Відбиткові ложки
 - Cubetas para impresiones
 - صواني الانطباع

PERFORATED FULL DENTURE

Set of 8 Pcs

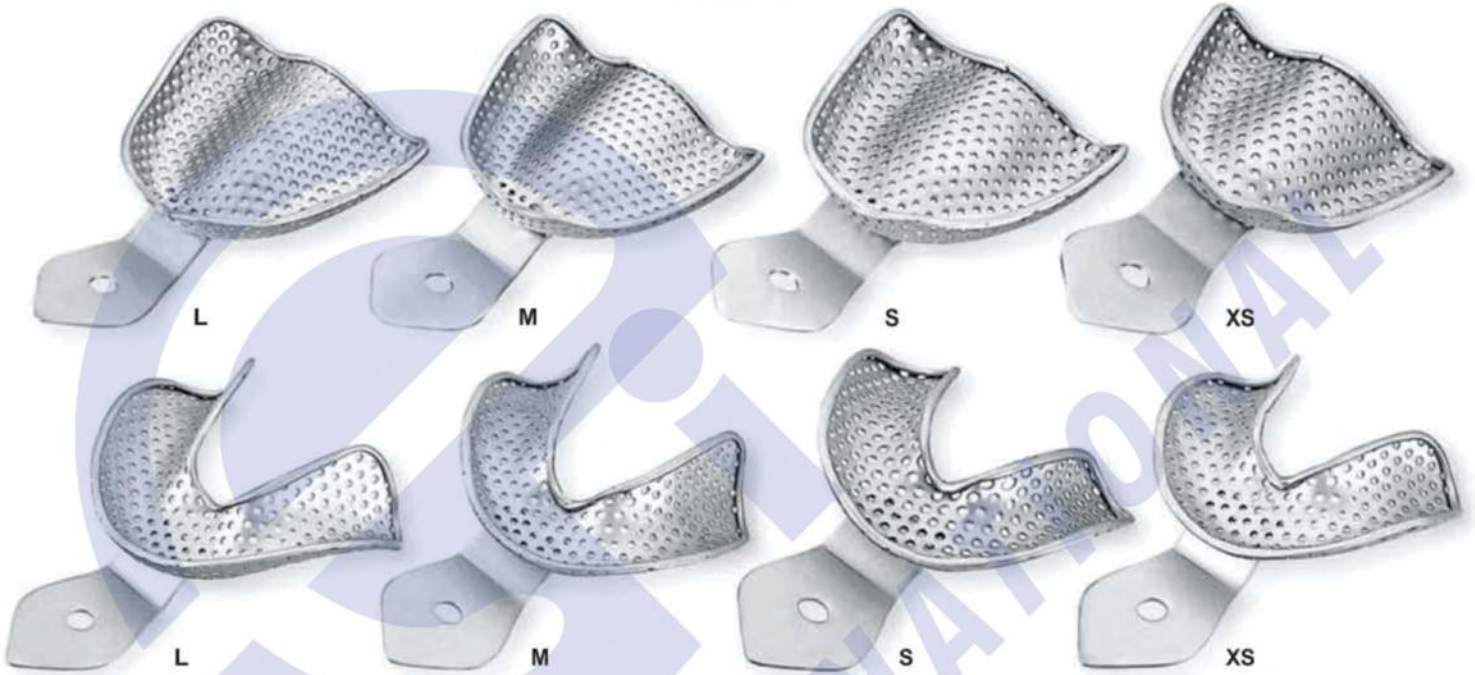

EI-5738 **SET OF 08 PCS**
Upper: S, M, L, XL
Lower: S, M, L, XL

EI-5739 **SET OF 08 PCS**
Upper: S, M, L
Lower: S, M, L

SOLID FULL DENTURE

Set of 8 Pcs



EI-5740 **SET OF 08 PCS**
Upper: S, M, L, XL
Lower: S, M, L, XL

EI-5741 **SET OF 06 PCS**
Upper: S, M, L
Lower: S, M, L

IMPRESSION TRAYS

- Оттисные ложки
- Porte-empreinte
- Abdrucklöffel
- Відбиткові ложки
- Cubetas para impresiones
- صواني الانطباع

Perforated Without Rim Lock

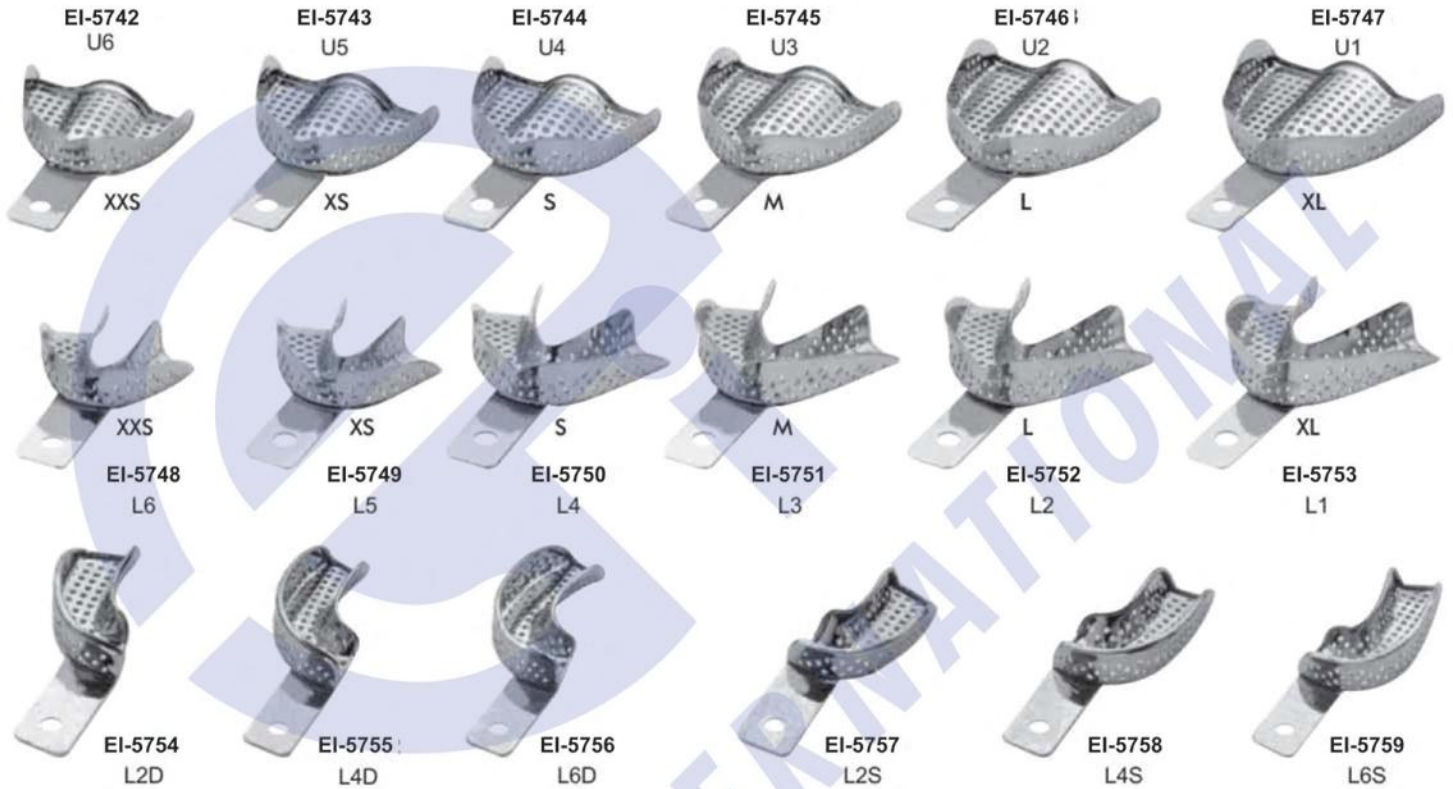

Solid With Rim Lock

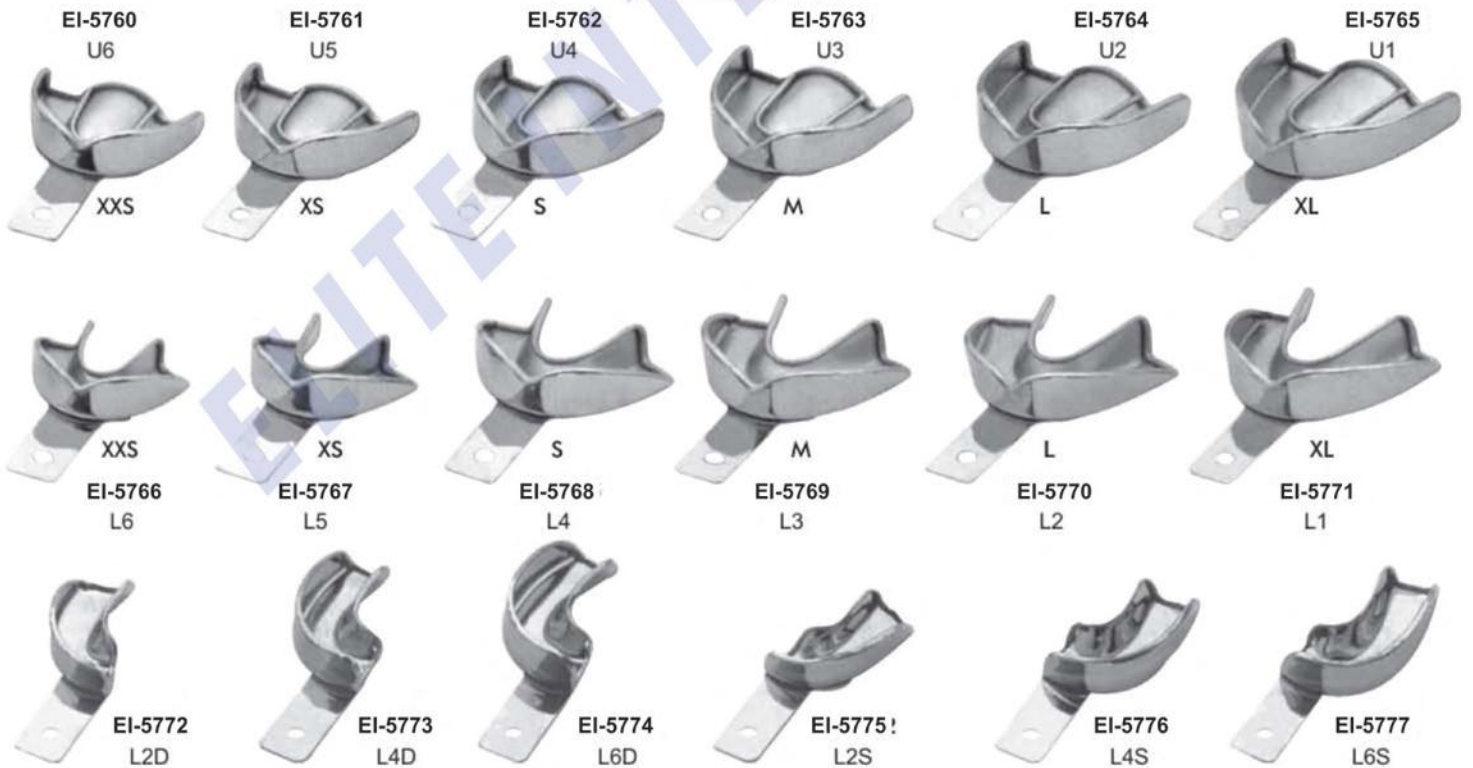





Scalers Tray
EI-5778 200 x 100 mm



Scalers Trays
EI-5779 205 x 115 x 17 mm
EI-5780 205 x 152 x 17 mm
EI-5781 290 x 115 x 17 mm

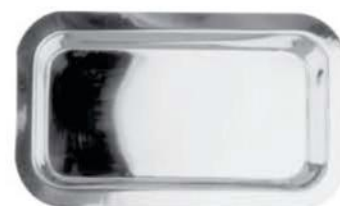

Instruments Trays
EI-5782 200 x 110 x 30 mm
EI-5783 215 x 115 x 35 mm
EI-5784 220 x 130 x 30 mm
EI-5785 230 x 125 x 35 mm
EI-5786 245 x 140 x 40 mm
EI-5787 285 x 160 x 45 mm
EI-5788 315 x 175 x 50 mm
EI-5789 330 x 185 x 50 mm



Instruments Trays
EI-5790 150 x 100 x 50 mm
EI-5791 200 x 100 x 50 mm
EI-5792 220 x 120 x 50 mm
EI-5793 240 x 140 x 50 mm
EI-5794 200 x 150 x 50 mm
EI-5795 250 x 200 x 50 mm
EI-5796 300 x 250 x 50 mm
EI-5797 300 x 200 x 50 mm
EI-5798 350 x 250 x 50 mm
EI-5799 400 x 300 x 50 mm
EI-5800 450 x 300 x 50 mm
EI-5801 450 x 350 x 50 mm



Instruments Trays With Lid
EI-5802 150 x 100 x 50 mm
EI-5803 200 x 100 x 50 mm
EI-5804 220 x 120 x 50 mm
EI-5805 240 x 140 x 50 mm
EI-5806 200 x 150 x 50 mm
EI-5807 250 x 200 x 50 mm
EI-5808 300 x 250 x 50 mm
EI-5809 300 x 200 x 50 mm
EI-5810 350 x 250 x 50 mm
EI-5811 400 x 300 x 50 mm
EI-5812 450 x 300 x 50 mm
EI-5813 450 x 350 x 50 mm



Mayo Tray Perforated
EI-5814 150 x 100 x 25 mm
EI-5815 200 x 100 x 25 mm
EI-5816 220 x 120 x 25 mm
EI-5817 240 x 140 x 25 mm
EI-5818 200 x 150 x 25 mm
EI-5819 250 x 200 x 25 mm
EI-5820 300 x 250 x 25 mm
EI-5821 300 x 200 x 25 mm
EI-5822 350 x 250 x 25 mm
EI-5823 400 x 300 x 25 mm
EI-5824 450 x 300 x 25 mm
EI-5825 450 x 350 x 25 mm



Scaler Tray
EI-5826 200 x 115 mm
EI-5827 205 x 150 mm
EI-5828 290 x 150 mm
EI-5829 300 x 200 mm



Instruments Tray Perforated
EI-5830 150 x 100 x 50 mm
EI-5831 200 x 100 x 50 mm
EI-5832 220 x 120 x 50 mm
EI-5833 240 x 140 x 50 mm
EI-5834 200 x 150 x 50 mm
EI-5835 250 x 200 x 50 mm
EI-5836 300 x 250 x 50 mm
EI-5837 300 x 200 x 50 mm
EI-5838 350 x 250 x 50 mm
EI-5839 400 x 300 x 50 mm
EI-5840 450 x 300 x 50 mm
EI-5841 450 x 350 x 50 mm

HOLLOWARE INSTRUMENTS

Sterilizing boxes & instruments Trays



Instruments Box with Hooks

EI-5842	170 x 70 x 30 mm
EI-5843	180 x 80 x 40 mm
EI-5844	200 x 100 x 40 mm
EI-5845	200 x 100 x 50 mm
EI-5846	220 x 120 x 50 mm
EI-5847	250 x 150 x 50 mm
EI-5848	250 x 200 x 50 mm
EI-5849	300 x 150 x 60 mm
EI-5850	300 x 200 x 50 mm
EI-5851	350 x 250 x 50 mm
EI-5852	400 x 200 x 100 mm
EI-5853	450 x 250 x 50 mm



Instruments Box

EI-5854	170 x 70 x 30 mm
EI-5855	180 x 80 x 40 mm
EI-5856	200 x 100 x 40 mm
EI-5857	200 x 100 x 50 mm
EI-5858	220 x 120 x 50 mm
EI-5859	250 x 150 x 50 mm
EI-5860	250 x 200 x 50 mm
EI-5861	300 x 150 x 60 mm
EI-5862	300 x 200 x 50 mm
EI-5863	350 x 250 x 50 mm
EI-5864	400 x 200 x 100 mm
EI-5865	450 x 250 x 50 mm



Instruments Box Perforated

EI-5866	170 x 70 x 30 mm
EI-5867	180 x 80 x 40 mm
EI-5868	200 x 100 x 40 mm
EI-5869	200 x 100 x 50 mm
EI-5870	220 x 120 x 50 mm
EI-5871	250 x 150 x 50 mm
EI-5872	250 x 200 x 50 mm
EI-5873	300 x 150 x 60 mm
EI-5874	300 x 200 x 50 mm
EI-5875	350 x 250 x 50 mm
EI-5876	400 x 200 x 100 mm
EI-5877	450 x 250 x 50 mm



Gloves Box

EI-5878 300 x 150 mm



Catheters Tray with lid

EI-5879	200 x 60 x 40 mm
EI-5880	200 x 90 x 40 mm
EI-5881	320 x 95 x 50 mm
EI-5882	328 x 90 x 50 mm
EI-5883	365 x 90 x 50 mm
EI-5884	440 x 115 x 50 mm



Box With Filter

EI-5885	100 x 50 mm
EI-5886	250 x 150 mm
EI-5887	150 x 65 mm
EI-5888	200 x 100 mm
EI-5889	300 x 200 mm



Instruments Trays With Cover

EI-5890	210 x 110 x 50 mm
EI-5891	240 x 160 x 50 mm
EI-5892	300 x 180 x 50 mm
EI-5893	360 x 210 x 50 mm
EI-5894	400 x 230 x 55 mm

Instruments Trays Without Cover

EI-5895	210 x 110 x 50 mm
EI-5896	240 x 160 x 50 mm
EI-5897	300 x 180 x 50 mm
EI-5898	360 x 210 x 50 mm
EI-5899	400 x 230 x 55 mm



Instruments Box with lid

EI-5900	170 x 70 x 30 mm
EI-5901	180 x 80 x 40 mm
EI-5902	200 x 100 x 40 mm
EI-5903	200 x 100 x 50 mm
EI-5904	220 x 120 x 50 mm
EI-5905	250 x 150 x 50 mm
EI-5906	250 x 200 x 50 mm
EI-5907	300 x 150 x 60 mm
EI-5908	300 x 200 x 50 mm
EI-5909	350 x 250 x 50 mm
EI-5910	400 x 200 x 100 mm
EI-5911	450 x 250 x 50 mm



Kidney Tray
 EI-5912 160 mm
 EI-5913 200 mm
 EI-5914 250 mm
 EI-5915 280 mm
 EI-5916 300 mm



Kidney Tray Shallow
 EI-5917 170 mm
 EI-5918 220 mm
 EI-5919 240 mm



Kidney Tray With Cover
 EI-5920 160 mm
 EI-5921 200 mm
 EI-5922 250 mm
 EI-5923 280 mm
 EI-5924 300 mm



Kidney Tray
 EI-5925 160 mm
 EI-5926 200 mm
 EI-5927 250 mm
 EI-5928 280 mm
 EI-5929 300 mm



Forceps Jars
 EI-5930 30 x 90 mm
 EI-5931 50 x 100 mm
 EI-5932 50 x 130 mm
 EI-5933 50 x 175 mm
 EI-5934 75 x 100 mm
 EI-5935 75 x 130 mm
 EI-5936 75 x 175 mm
 EI-5937 100 x 175 mm
 EI-5938 100 x 200 mm



Methot Jar Without Lid
 EI-5939



Dressing Jar / Cotton Container
 EI-5940 80 x 80 mm
 EI-5941 100 x 60 mm
 EI-5942 100 x 80 mm
 EI-5943 100 x 100 mm
 EI-5944 120 x 80 mm
 EI-5945 120 x 100 mm
 EI-5946 150 x 100 mm
 EI-5947 150 x 150 mm
 EI-5948 180 x 150 mm
 EI-5949 180 x 180 mm
 EI-5950 200 x 200 mm
 EI-5951 240 x 240 mm



Sputum Cup
 EI-5952



Dressing Jar With Lid & Knob
 EI-5953 80 x 80 mm
 EI-5954 90 x 90 mm
 EI-5955 100 x 100 mm
 EI-5956 120 x 120 mm
 EI-5957 100 x 130 mm
 EI-5958 150 x 150 mm
 EI-5959 125 x 170 mm



Round Bowls
 EI-5960 80 x 35 mm
 EI-5961 125 x 60 mm

HOLLOWWARE INSTRUMENTS



Spirit Lamp
EI-5962



Spirit Lamp
EI-5963



Spirit Lamp
EI-5964



Cotton Holding Jar
EI-5965



Cotton Holder
EI-5966



Cotton Holder
EI-5967



Cotton Wool Dispenser Acc.
to Methot
EI-5968



Needle Sterilization Tub
EI-5969



Round Endodontic Boxes
complete with lid
EI-5970 : Ø mm. 94 - h. mm. 70



Endodontic Box
EI-5971

HOLLOWARE INSTRUMENTS



EI-5972
100 x 180 x 11mm
Mini size



EI-5973
100 x 180 x 11mm
Mini size



EI-5974
100 x 180 x 11mm
Mini size



EI-5975
100 x 180 x 11mm
Mini size



EI-5976
100 x 180 x 11mm
Mini size



EI-5977
103 x 182 x 10mm
Mini size

Lid
Coperchio



EI-5978
Silver



EI-5979 Blue
EI-5980 Red



EI-5981 Blue
EI-5982 Red



EI-5983
Silver



EI-5984
Green



EI-5986
Blue



EI-5985
Golden



EI-5987
Red



EI-5988
Silver



EI-5989
Midi
125 x 105 x 54mm



EI-5990
Maxi
204 x 105 x 54mm

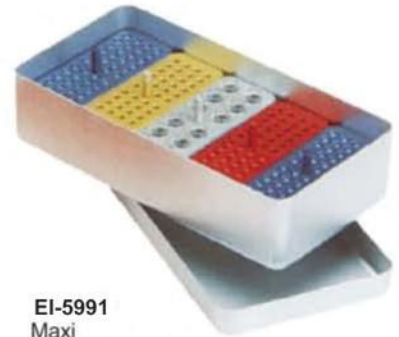

EI-5991
Maxi
204 x 105 x 54mm



Round Sterilizer Drum

EI-5992	mm. Ø 80 x 80 H
EI-5993	mm. Ø 125 x 80 H
EI-5994	mm. Ø 125 x 100 H
EI-5995	mm. Ø 125 x 125 H
EI-5996	mm. Ø 150 x 80 H
EI-5997	mm. Ø 150 x 100 H
EI-5998	mm. Ø 150 x 130 H
EI-5999	mm. Ø 150 x 150 H
EI-6000	mm. Ø 150 x 190 H
EI-6001	mm. Ø 190 x 125 H
EI-6002	mm. Ø 190 x 145 H
EI-6003	mm. Ø 190 x 165 H
EI-6004	mm. Ø 190 x 190 H
EI-6005	mm. Ø 190 x 240 H
EI-6006	mm. Ø 190 x 290 H
EI-6007	mm. Ø 240 x 120 H
EI-6008	mm. Ø 240 x 145 H
EI-6009	mm. Ø 240 x 165 H
EI-6010	mm. Ø 240 x 190 H
EI-6011	mm. Ø 240 x 240 H
EI-6012	mm. Ø 240 x 290 H
EI-6013	mm. Ø 240 x 340 H
EI-6014	mm. Ø 240 x 390 H
EI-6015	mm. Ø 290 x 145 H
EI-6016	mm. Ø 290 x 165 H
EI-6017	mm. Ø 290 x 190 H
EI-6018	mm. Ø 290 x 240 H
EI-6019	mm. Ø 290 x 290 H
EI-6020	mm. Ø 290 x 340 H
EI-6021	mm. Ø 290 x 390 H
EI-6022	mm. Ø 340 x 145 H
EI-6023	mm. Ø 340 x 165 H
EI-6024	mm. Ø 340 x 190 H
EI-6025	mm. Ø 340 x 240 H
EI-6026	mm. Ø 340 x 290 H
EI-6027	mm. Ø 340 x 340 H
EI-6028	mm. Ø 340 x 390 H
EI-6029	mm. Ø 390 x 140 H
EI-6030	mm. Ø 390 x 165 H
EI-6031	mm. Ø 390 x 190 H
EI-6032	mm. Ø 390 x 240 H
EI-6033	mm. Ø 390 x 290 H
EI-6034	mm. Ø 390 x 340 H
EI-6035	mm. Ø 390 x 390 H
EI-6036	mm. Ø 390 x 490 H

Round Sterilizer Drums "Filter"

EI-6037	mm. Ø 80 x 80 H
EI-6038	mm. Ø 80 x 80 H
EI-6039	mm. Ø 125 x 80 H
EI-6040	mm. Ø 125 x 100 H
EI-6041	mm. Ø 125 x 125 H
EI-6042	mm. Ø 150 x 100 H
EI-6043	mm. Ø 150 x 130 H
EI-6044	mm. Ø 150 x 150 H
EI-6045	mm. Ø 150 x 190 H
EI-6046	mm. Ø 190 x 145 H
EI-6047	mm. Ø 190 x 165 H
EI-6048	mm. Ø 190 x 190 H
EI-6049	mm. Ø 190 x 240 H
EI-6050	mm. Ø 240 x 145 H
EI-6051	mm. Ø 240 x 165 H
EI-6052	mm. Ø 240 x 190 H
EI-6053	mm. Ø 240 x 240 H
EI-6054	mm. Ø 240 x 290 H
EI-6055	mm. Ø 240 x 340 H
EI-6056	mm. Ø 240 x 390 H
EI-6057	mm. Ø 290 x 145 H
EI-6058	mm. Ø 290 x 165 H
EI-6059	mm. Ø 290 x 190 H
EI-6060	mm. Ø 290 x 240 H
EI-6061	mm. Ø 290 x 290 H
EI-6062	mm. Ø 290 x 340 H
EI-6063	mm. Ø 290 x 390 H
EI-6064	mm. Ø 340 x 145 H
EI-6065	mm. Ø 340 x 165 H
EI-6066	mm. Ø 340 x 190 H
EI-6067	mm. Ø 340 x 240 H
EI-6068	mm. Ø 340 x 290 H
EI-6069	mm. Ø 390 x 140 H
EI-6070	mm. Ø 390 x 165 H
EI-6071	mm. Ø 390 x 190 H
EI-6072	mm. Ø 390 x 240 H
EI-6073	mm. Ø 390 x 290 H
EI-6074	mm. Ø 390 x 340 H
EI-6075	mm. Ø 390 x 490 H

Round Bowls With Cover

EI-6076	Ø 40 mm ml.30
EI-6077	Ø 60 mm ml.50
EI-6078	Ø 80 mm ml.150
EI-6079	Ø 100 mm ml.250
EI-6080	Ø 120 mm ml.450
EI-6081	Ø 150 mm ml.750
EI-6082	Ø 180 mm ml.1500
EI-6083	Ø 200 mm ml.2100
EI-6084	Ø 250 mm ml.3500

Round Bowls With Out Cover

EI-6085	Ø 40 mm ml.30
EI-6086	Ø 60 mm ml.50
EI-6087	Ø 80 mm ml.150
EI-6088	Ø 100 mm ml.250
EI-6089	Ø 120 mm ml.450
EI-6090	Ø 150 mm ml.750
EI-6091	Ø 180 mm ml.1500
EI-6092	Ø 200 mm ml.2100
EI-6093	Ø 250 mm ml.3500

INSTRUMENTS MANAGEMENT SYSTEM

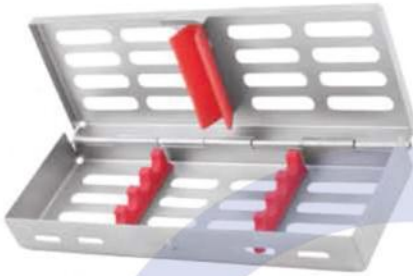

Cassette For 4 Instruments
EI-6094



Cassette For 5 Instruments
EI-6095

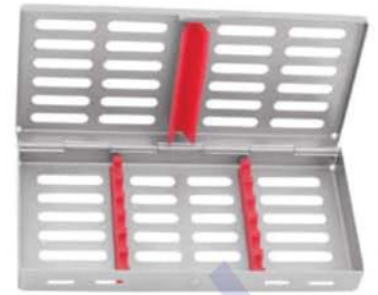

Cassette For 6 Instruments
EI-6096



Cassette For 7 Instruments
EI-6097

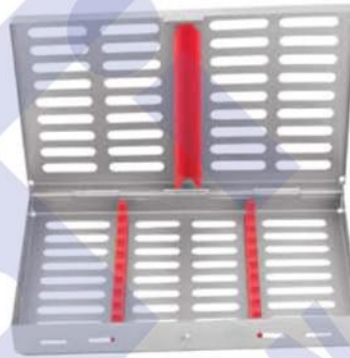

Cassette For 10 Instruments
EI-6098



Cassette For 20 Instruments
EI-6099



Cassette For Extraction Forceps
EI-6100



Cassette For Root Elevator
EI-6101



EI-6102
Cassette Tray
15 Pcs



EI-6103
Cassette Tray
15 Pcs

HOLLOWARE INSTRUMENTS

STERILIZING MESH TRAY

Different sizes & dimensions are available at buyer's demand



MESH TRAYS
EI-6104
Different sizes & dimensions are available at buyer's demand

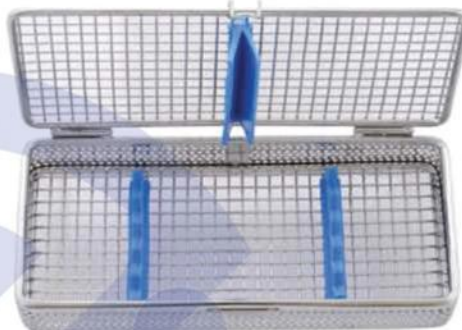

MESH TRAYS
EI-6105
05 Pcs



MESH TRAYS
EI-6106
07 Pcs



MESH TRAYS
EI-6107
10 Pcs



MESH TRAYS
EI-6108
20 Pcs



EI-6109
Mesh Cassettes
5 Pieces, 7 Pieces, 10 Pieces, 15 Pieces & 20 Pieces



MESH TRAY
EI-6110 240x130x50mm
EI-6111 240x130x60mm
EI-6112 240x250x50mm
EI-6113 240x250x60mm
EI-6114 480x250x50mm
EI-6115 480x250x60mm
EI-6116 480x250x70mm



MESH TRAY
EI-6117 240x250x 50mm
EI-6118 240x250x 60mm
EI-6119 240x250x 70mm
EI-6120 480x250x 50mm
EI-6121 480x250x 60mm
EI-6122 480x250x 70mm
EI-6123 480x250x100mm



MESH TRAY
EI-6124 240x250x50mm
EI-6125 240x250x60mm
EI-6126 240x250x70mm
EI-6127 280x250x50mm
EI-6128 280x250x60mm



MESH TRAY
EI-6129 280x250x 70mm
EI-6130 280x250x100mm
EI-6131 280x250x 50mm
EI-6132 280x280x 60mm
EI-6133 280x280x 70mm
EI-6134 300x280x 60mm

HOLLOWWARE INSTRUMENTS



EI-6135
18×7×3.5cm
5 Instruments Cassette
Detachable Lids
+
5 Instruments Cassette Hinged
Lids with button Lock



EI-6136
29×18.5×3.5cm
20 Instruments Cassette Hinged
Lids with surgical kit fitting,
button lock



Instruments Cassette
EI-6137 5 Pieces Cassette
EI-6138 7 Pieces Cassette
EI-6139 10 Pieces Cassette



EI-6140
18×11×3.5cm
Extra large cassette for 6
Instruments, with compartment
for small parts hinged lids



EI-6141
29×18.5×3.5cm
20 Instruments Cassette
Detachable Lids
+
20 Instruments Cassette Hinged
Lids with button Lock

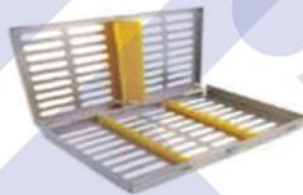

EI-6142
10×13×2.2cm
10 Instruments Cassette Hinged
Lids, Click Lock Available in 2
designs



EI-6143
29×18.5×3.5cm
20 Instruments Cassette Detachable
Lids with elevator fitting
+
20 Instruments Cassette Hinged
Lids with elevator fitting , button lock

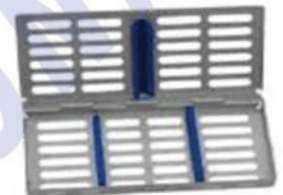

EI-6144
18×9×2.2cm
7 Instruments Cassette Hinged
Lids, Click Lock, Available in 2
designs



EI-6145
21×14×3.5cm
15 Instruments cassette,
Detachable lids, button lock



EI-6146
21×14×3.5cm
15 Instruments cassette,
detachable lids, button
lock, with fitting of micro
surgery kit



EI-6147
21×14×4.5cm
8 pcs luxator/elevator
cassette, Detach0
ablelids, button lock



EI-6148
15×9×5cm
Box for dental implant tools and
surgical kits, Capacity:8
tools, 18 tools, 24 Tools, 58 Tools
+ removable compartment



Instruments Tray Perforated
EI-6149 288 x 187 x 40 mm



Instruments Tray Perforated Base
EI-6150 288 x 187 x 40 mm



Instruments Tray Solid Base
EI-6151 288 x 187 x 40 mm



EI-6152 Implant Basic Starter Kit 11 instruments with case



EI-6153 Crown Bridge Set Instruments with Case



EI-6154 Bone Curettes Spoon Style set of 4 with Metal Case



EI-6155 Peritome Set of 2 with Blue Nitrate Tips and Metal Case

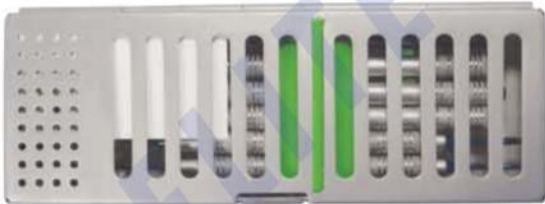

EI-6156 Root Fragment Removal elevators, Set of 4 with Metal Case



EI-6157 Peritome Set of 3 Gold Handles Serrated Blades with Metal Case



INDEX

DESCRIPTION PAGE#

A
A COSMETIC CONTOURING IMPLANTOLOGY 148
AB1 BOGHOSIAN IMPLANTOLOGY 147
AB2 BOGHOSIAN IMPLANTOLOGY 147
ABOU-RASS EXPLORERS 54
ACUTE IMPLANTOLOGY 161
ADAMS PLIER 133
ADAMS PLIER ROUND BOX 133
ADAMS PLIERS FOR HOOKS AND BENDING 138
ADAMS, SMALL WIRE BENDING AND LOOP FORMING PLIERS 132
ADERER CLAMP THREE JAW WIRE BENDING PLIER 138
ADERER FACEBOW LOOP FORMING PLIERS 134
ADERER LARGE WIRE BENDING AND LOOP FORMING PLIERS 133
ADERER PLIER 134
ADHESIVE REMOVING PLIERS 36,141
ADSON 7X7 CURVED TISSUE FORCEPS 169
ADSON BROWN TWEEZERS 53
ADSON CARBIDE TIPPED TISSUE FORCEPS 169
ADSON NEEDLE HOLDERS 107
ADSON-TC TWEEZERS 53
ADULT PALATAL DENTAL PHOTOGRAPHIC MIRRORS 98
ALLIS HAEMOSTATIC FORCEPS 110
ALLIS-BABY HAEMOSTATIC FORCEPS 110
ALL-PURPOSE PLIERS 109
ALUMINIUM CALIPER 127
ALM RETRACTOR 102
AMALGAM CARRIERS 117
AMALGAM INSTRUMENTS 116,117
AMALGAM WELL 115,117
ANATOMIC HANDLE EXPLORERS 54
ANDREWS FILLING INSTRUMENTS 87
ANGLE HOW PLIER 139
ANGLED DIRECT BOND BRACKET REMOVER TC 139
ANGLED EXTRACTING FORCEPS FOR UPPER ROOTS 03
ANGLED UTILITY PLIERS 136
ANISWORTH RUBBER DAM CLAMPS FORCEPS 111
ANTERIOR 58
APEX FORCEPS LOWER ROOT DEEP ROOT PICK 06
APEX FORCEPS LOWER UNIVERSAL DEEP ROOT PICK 05
APEXO ROOT ELEVATORS 29
APICAL RETENTION FORCEPS 23
APICAL ROOT ELEVATORS 31,33
ARCH BENDING PLIERS 38,143
ARROW CLASP FORMING PLIERS 139
ARTICULATORS 97
ASPIRATING SYRING 27
ATRAUMATIC TWEEZERS 52
ATRAUMATIC WITH LOCK TWEEZERS 52

B
BABY TOOTH EXTRACTION FORCEPS SET OF 7 PIECES 08
BACK ACTION FILLING INSTRUMENTS 88
BACKHAUS HAEMOSTATIC FORCEPS 110
BACKHAUS TOWEL CLAMPS 110
BACOLITE HANDLE WAX KNIVES 96
BALL BURNISHERS 71
BALL FILLING INSTRUMENTS 93
BALL SOCKET NOT-PERFORATING AND NOT-DAMAGING 110
BALL ACORN FILLING INSTRUMENTS 88
BAND REMOVING PLIERS 126,136
BAND SEATER AUTO CLEAVABLE 129
BAND SEATER AUTO CLEAVABLE ROUND SHAPE 129
BAND SEATER AUTO CLEAVABLE SQUARE SHAPE 129
BAND SEATER AUTO CLEAVABLE TRIANGLE SHAPE 129
BAND SEATING & REMOVING INSTRUMENTS 129
BAND SEATING & REMOVING SILICON GRIP 129
BAND SEATING PLIERS 141
BANDS & CROWNS PLIER 134
BARRAQUER T.C NEEDLE HOLDERS 109
BASINS FOR BONE 174
BAUMGARTNER NEEDLE HOLDERS 06,107
BAYONET ROOTS ELEVATOR SET 36
BEAVERTAIL FILLING INSTRUMENTS 88
BEEBEE GUM SCISSORS 106
BEERENDONK CALIPER 127
BEIN ROOT ELEVATORS 29,40
BENDING PLIER 138
BESEK COMPOSITE INSTRUMENTS 72
BESEK COMPOSITE MODELLING INSTRUMENTS 85
BESEK COMPOSITE PLUGGERS INSTRUMENTS 82
BESEK PLUGGERS 76
BEYER BONE ROUNDING 25
BINANGLE SCALER 67
BIRD BEAK PLIER 38,141
BIRD BEAK PLIER FOR BENDING 138
BIRD BEAK PLIER STANDARD 133
BIRD BEAK WIRE BENDING & CUTTING PLIERS 134
BIRD BEAK WIRE BENDING PLIER 133
BISHOP RETRACTORS 101
BLACK FILLING INSTRUMENTS 80,87
BLACK SCALER 66
BLACK TITANIUM COLOUR COATED INSTRUMENTS 147,148,149
BLADE AND PUSHER 166
BLUE TITANIUM COATED BONE GRAFTING INSTRUMENTS 59,187
SET OF 7 PCS WITH CASSETTE 159
BLUMENTHAL BONE ROUNDING 25
BOLEY GAUGE 127
BONE BRACKET GAUGE 125
BONE CARRIER TITANIUM 165
BONE CRUSHER 174
BONE CRUSHER TITANIUM METAL CUTTER 174
BONE EXPANDER KIT 176
BONE EXPANDER SCREW & SURGICAL KITS 176
BONE FILES 119
BONE GRAFT 159
BONE GRAFT IMPLANTOLOGY 156
BONE GRAFT PACKER 164
BONE GRAFT/CARRIER TITANIUM 167
BONE GRAFTING INSTRUMENTS COMPACTOR /TAMPERS 166
BONE INJECTORS, COLLECTORS & SUCTION TUBE 175
BONE MILL 174
BONE ROUNDING 25
BONE SCRAPER 173
BONE SCRAPER STRAIGHT & CURVED 173
BONE SPOON/PACKER 166

DESCRIPTION PAGE#

BONE THICKNESS GAUGE 146
BONE UNIVERSAL KIT 176
BONE WELL 174
BOX FOR DENTAL IMPLANT TOOLS AND SURGICAL KITS, 191
BOX JOINT PLIERS 132,133,134
BRACKET HOLDER TWEEZERS 128
BRACKET PLACER TWEEZERS 128
BRACKET PLACING TWEEZES 128
BRACKET REMOVING PLIER CURVED 132
BRACKET REMOVING PLIER ROUND BOX 132
BRACKET REMOVING PLIERS ANGLED 136
BRACKET REMOVING PLIERS STRAIGHT 136
BRACKET REMOVING PLIERS WITH PLASTIC TIP 136
BRACKET TWEEZERS SLOT ALIGNER 126
BREWER RUBBER DAM CLAMPS FORCEPS 111
BRUENINGS RETRACTORS 101
BUCCAL AND LINGUAL/PALATAL SCALER 61
BUCCAL DENTAL PHOTOGRAPHIC MIRRORS 98
BUCCAL SURFACES SCALER 61
BUCCAL-SMALL DENTAL PHOTOGRAPHIC MIRRORS 98
BURNISHER FILLING INSTRUMENTS 78,88
BURNISHERS 149
BURNISHERS CONSERVATIVE TREATMENT 68,71
BUSER PERIODONTAL INSTRUMENTS 121

C
COSMETIC CONTOURING IMPLANTOLOGY 148
CARBIDE DIAMOND COATED POINT 24
CARRY FORCEPS 170
CARVER COMPOSITE MODELLING INSTRUMENTS 85
CARVERS INSTRUMENTS 89,90
CARVERS INSTRUMENTS CASSETTE FOR 5 INSTRUMENTS 90
CASSETTE FOR INSTRUMENTS 162
CASTROVIEJO CALIPERS 126
CASTROVIEJO GUM SCISSORS 105
CASTROVIEJO MICRO SCISSORS 108
CASTROVIEJO NEEDLE HOLDERS 107,109
CATHETERS TRAY WITH LID BOX WITH FILTER 184
CATRIDGE SYRING 27
CEMENT SPATULAS 95
CERI SAW 124
CHEEK RETAINER 101
CHILD PALATAL DENTAL PHOTOGRAPHIC MIRRORS 98
CHIP BLOWER 116
CHISELS, BONE FILES & SPOONE CURETTE 118
CHISELS SCALER 65,67
CHOMPRET ROOT ELEVATOR 42
CINCH BACK / TIE BACK DISTAL END BENDING PLIERS 137
CLAW-LIFT ROOTS ELEVATOR 37
COARSE SUCTION TUBES 178
COBRA IMPLANTOLOGY 156
COHEN UNIVERSAL EXTRACTING FORCEPS (AMERICAN PATTERN) 17
COLLEGE FORCEPS 51
COLLEGE TWEEZER 53
COLLEGE WITH LOCK TWEEZERS 52
COLLINS TONGUE FORCEPS 110
COLUMBIA RETRACTOR 99
COMBINATION RETRACTORS 101
COMELLAS FORCEPS ANATOMICAL HANDLE 26
COMPASSO DE WILLIS 127
COMPOSITE BALL PLUGGERS 76
COMPOSITE FILLING INSTRUMENTS 92,93
COMPOSITE FILLING INSTRUMENTS SET OF 6 PCS 153
COMPOSITE GOLD TIP INSTRUMENTS 93
COMPOSITE INSTRUMENTS 72,73
COMPOSITE INSTRUMENTS BLUE TITANIUM WITH CASSETTES 89
COMPOSITE INSTRUMENTS TITANIUM BLUE ENDODONTIC 89
COMPOSITE MODELLING INSTRUMENTS 85
COMPOSITE PLUGGERS INSTRUMENTS 82,83
COMPOSITE/PLASTIC FILLING INSTRUMENTS 87
CONDENSER IMPLANTOLOGY 150,161
CONE-SOCKET MOUTH MIRRORS 49
CONE-SOCKET FRONT SURFACE MOUTH MIRRORS 49
CONE-SOCKET MIRROR HANDLES FOR MOUTH MIRRORS 50
CONE-SOCKET PLAIN MOUTH MIRRORS 49
CONE-SOCKET RHODIUM MOUTH MIRRORS 49
CONE-SOCKET SOLID HANDLES FOR MOUTH MIRRORS 50
CONE-SOCKET SOLID OCTAGONAL HANDLES FOR MOUTH MIRRORS 50
CONTOURING PLIER 134,138
COPERCHIO HOLLOWWARE INSTRUMENTS 145
CORROSION-RESISTANT 186
COTTON HOLDER 186
COTTON HOLDING JAR 186
COTTON WOOL DISPENSER ACC. TO METHOT 186
COUPLAND ROOT ELEVATORS 34
CRANE KAPLAN TWEEZERS 53
CRILE-WOOD NEEDLE HOLDERS 106,107
CROWN REMOVER 114
CROWN SPREADERS 114
CRUCIBLE TONGS 124
CRYER EXTRACTING FORCEPS (AMERICAN PATTERN) 12,13,19,20
CRYER ROOT ELEVATORS 32
CUTTER 139,142
CUTTER, UTILITY PLIERS & WIRE FORMING PLIERS 141

D
DEAN GUM SCISSORS 105
DEBAKEY ATRAUMATIC TISSUE FORCEPS 160
DELUX BOLEY GAUGE 127
DELUXE BRACKET HOLDER 128
DELUXE BRACKET HOLDER TWEEZERS 128
DENHARD RETRACTORS - MOUTH GAGS 100
DENTAL PHOTOGRAPHIC MIRRORS 98
DENTAL SYRINGES 27
DENTAURUM CALIPER 127
DERF NEEDLE HOLDERS 106,107
DETAILING STEP PLIER 139
DETAILING STEP PLIERS / BAYONET BENDING PLIERS 137
DIAMOND COATED MARGIN TRIMMERS 65
DIRECT BOND BRACKET HOLDER TWEEZERS 128
DIRECT BOND BRACKET HOLDER TWEEZERS, SMALL TIP 128
DIRECT BONDING BRACKET HOLDERS 128
DIRECT BRACKET REMOVER TC 140
DISC SYSTEM DENTAL SYRINGES 27
DISSECTING SET SET OF 11 PCS 94
DISSECTING SET SET OF 9 PCS 94

DESCRIPTION PAGE#

DISTAL AMALGAM CARRIERS	117
DISTAL BENDER SILICON GRIP	129
DISTAL CUTTER	139
DISTAL END CUTTER	135
DISTAL END CUTTER FLUSH CUT	142
DISTAL END CUTTER, SAFETY HOLD PLIER (IDEAL FOR CUTTING WIRE) TC	140
DISTAL END, WIRE CUTTERS & BRACKET REMOVER PLIERS	140
DISTAL SCALER	61,63
DOUBLE ENDED CEMENT SPATULA	131
DOUBLE ROUNDED JAW BENDING PLIERS	138
DOUBLE-ENDED EXPLORERS	54
DRESSING TWEEZERS	52,53
DYNAMOMETER	146

E	
EASY ACCESS TWEEZES	128
EBNETER SCALER	64
ELASTIC INSTRUMENT SILICON GRIP	129
ELASTIC SEPARATING PLIER	140
ELASTIC SEPARATING PLIER ROUND HANDLE	140
ELASTOMERIC LIGATURE PLACING FORCEPS WITH GROOVE FALCON	140
ELEVATORS SET OF 8 PCS	46
ELEVATORS SET OF 9 PCS	46
ELLIOT SIQVELAND RETAINERS	115
ENDO FINGER RULER SPAN MEASURE SCALE	125
ENDODONTIC BOX	186
ENDODONTIC EXPLORER	154
ENDODONTICS INSTRUMENTS	58
ERGO GRIP RETRACTOR	101
EURO BREECH LOADING/DENTAL SYRINGES	27
EXAVATORS EXPLORERS	51
EXCAVATOR INSTRUMENTS	74
EXCAVATORS	86
EXECT BRACKET HOLDER TWEEZERS	128
EXPLORERS	51,54,55,56
EXTRACTING FORCEPS (AMERICAN PATTERN)	120a24
EXTRACTING FORCEPS (ENGLISH PATTERN)	01to07,26

EXTRACTING FORCEPS (ENGLISH PATTERN) SET OF 10 PIECES	07
EXTRACTING FORCEPS	08
EXTRACTING FORCEPS AMERICAN ADULT SET OF 10 PCS	28
EXTRACTING FORCEPS AMERICAN ADULT SET OF 8 PCS	28
EXTRACTING FORCEPS CHILDREN PATTERN SET OF 10 PIECES	28
EXTRACTING FORCEPS ENGLISH ADULT SET OF 10 PCS	28
EXTRACTING FORCEPS PEDO SET OF 7 PCS	28
EXTRACTING FORCEPS SET	28
EXTRACTING FORCEPS SET OF 10 PIECES	28
EXTRACTING FORCEPS SET OF 10 PIECES	28
EXTRACTING FORCEPS SET OF 13 PIECES	28
EXTRA-FLEX IMPLANTOLOGY	147

F	
FALCON BEAK CONTOURING PLIERS	133,138
FARABEUF RETRACTORS SET OF 2 PIECES)	103
FELDMAN RETRACTOR	103
FILLING INSTRUMENTS (GOLD POINTED)	91
FILLING INSTRUMENTS	87,88,91,93
FILLING INSTRUMENTS CONSERVATIVE TREATMENT	69,70,75,78,79,81,84
FIRST AID EXAMINATION SET OF 3 PIECES	51
FLEXIBLE PERIOME	163
FLEXI-THIN IMPLANTOLOGY	147
FLOHR ROOT ELEVATORS	29,33
FLUCH-CUT DISTAL AND CUTTING PLIERS	133
FLUSH-CUT DISTAL END CUTTER	135
FOERSTER DRESSING FORCEPS	110
FRAZIER SUCTION TUBES WITH FILTER	178
FREEDMAN "DUCKHEAD"	149
FREEDMAN BURNISHERS	149
FREEDMAN LARGE CONTACT FORMING	149
FREEDMAN SMALL CONTACT FORMING	149
FREER PERIODONTAL INSTRUMENTS	121
FREER PERIOSTEAL ELEVATORS	120
FRET SAW	124
FRIEDMAN BONE ROUNDER	25
FRIEDMANN ROOT ELEVATOR	36
FRIEDMANN/RICHARD PERIODONTAL INSTRUMENTS	122
FUZZI COMPOSITE MODELLING INSTRUMENTS	85

G	
GERALD TWEEZERS	52
GILLES TWEEZERS	52
GILLIES NEEDLE HOLDER WITH SCISSORS	107
GLOVES BOX	184
GOLD COLOR SET DENTAL ORAL IMPLANTOLOGY SINUS SET OF 10 PCS WITH CASSETTE	156
GOLD MILL (LARGE)	174
GOLD MILL (SMALL)	174
GOLDMAN FOX SUPER CUT SCISSORS	108
GOLDMAN FOX EXPLORERS	55
GOLDMAN FOX SCISSORS	108
GOLDMAN-FOX GUM SCISSORS	104,105
GOLDMAN-FOX PERIODONTAL INSTRUMENTS	121
GOLDMANN-FOX SCALER	64
GRACEY AFTER FIVE	60
GRACEY CURETTES SCALER	60
GRACEY CURETTES	59,63
GRACEY MINI FIVE	60
GRACEY SCALER	61
GRAFT MATERIAL SPOON CONCAVE TIP FOR LARGER GRAFTS	165
GRAFT PACKER	166
GRAFT PACKER, CONCAVE	166
GRIPPER CARBIDE TIPPED TISSUE FORCEPS TC	169
GRITMAN CEMENT SPATULAS	95
GROSS MAIER DRESSING FORCEPS	110
GULDENER SCALER	64
GUM SCISSORS	104to108

H	
HAEMOSTATIC FORCEPS & TOWEL CLAMPS	110
HALSEY NEEDLE HOLDERS	106,107
HALSTEAD MOSQUITO HAEMOSTATIC FORCEPS	110
HALSTEAD MOSQUITO NEEDLE HOLDERS	107
HALTEPINZETTE WITH LOCK TWEEZERS	170

DESCRIPTION PAGE#

HAMMER HEAD DISTAL END BENDING PLIERS	137
HAMMER WITH WOODEN HANDLE	124
HANDLE ROUND HANDLES FOR MOUTH MIRRORS	50
HANDLES FOR MOUTH MIRRORS	50
HARD WIRE CUTTER	142
HARD WIRE CUTTER STRAIGHT	142
HARD WIRE CUTTER, 15° ANGLED	135
HARD WIRE CUTTER, 15° ANGLED NON-AUTOCALAVABLE	135
HARD WIRE CUTTER, STRAIGHT	135
HARD WIRE CUTTERS	140
HARRIS EXTRACTING FORCEPS (AMERICAN PATTERN)	13,18
HARTMANN (BABY MOSQUITO) NEEDLE HOLDERS	107
HEAT CARRIERS	57
HEBER BAYONET ROOTS ELEVATOR	40
HEBER ROOTS ELEVATOR	40
HEIDBRINK ROOT APPEX ELEVATOR	44
HEIDBRINK ROOT ELEVATORS	33,43
HEIDBRINK ROOTS ELEVATOR WARWICK-JAMES	44
HEIDEMANN FILLING INSTRUMENTS	93
HEIDEMANN SPATULAS	73
HEIGHT GAUGE 0.18 STAINLESS STEEL	125
HEIGHT GAUGE ALUMINUM	125
HEMINGWAY TWEEZERS	53
HEX TORQUE WRENCH UNIVERSAL	177
HEXAGONAL HANDLES FOR MOUTH MIRRORS	50
HIRSCHFELD PERIODONTAL INSTRUMENTS	122
HIRT COMPOSITE MODELLING INSTRUMENTS	85
HIRT COMPOSITE PLUGGERS INSTRUMENTS	83
HIRT SCALER	66
HMG HEISTER	99
HOLLENBACK FILLING INSTRUMENTS	80,87
HOLLOW CHOP CONTOURING PLIERS	143
HOLLOW HANDLES FOR MOUTH MIRRORS	50
HOLLOW MIRROR HANDLES FOR MOUTH MIRRORS	50
HOLLOWWARE INSTRUMENTS	183,184,186,187,190,191
HOLZ SCALER	65
HOOK CRIMPING PLIER ANGLED STRAIGHT TC	140
HOOK KNIVES	96
HOPSON FILLING INSTRUMENTS	78
HOW PLIER	132
HOW PLIER CURVED	132
HOW PLIERS OFFSET	141
HOW PLIERS STRAIGHT	141
HOW STRAIGHT UTILITY PLIERS	136
HOWARD PERIOSTEAL ELEVATORS	120
HULL EXTRACTING FORCEPS (AMERICAN PATTERN)	19
HYLIN CEMENT SPATULAS	95
HYLIN ROOTS ELEVATOR	39

I	
IMPLANT GAGES	145
IMPLANT SINUS LIFT INSTRUMENTS	161,162
IMPLANTOLOGY	145to178
IMPLANTOLOGY 9 PCS OF SET	161
IMPLANTOLOGY SET OF 2 COMPOSITE BLUE TIP INSTRUMENTS	154
IMPLANTOLOGY SET OF 3 COMPOSITE BLUE TIP INSTRUMENTS	154
IMPLANTOLOGY SET OF 4 COMPOSITE BLUE TIP INSTRUMENTS	154
IMPLANTOLOGY SET OF 5 COMPOSITE GOLD TIP INSTRUMENTS	154
IMPRESSION TRAYS	179to182
IMPRESSION TRAYS PERFORATED FULL DENTURE SET OF 8 PCS	181
IMPRESSION TRAYS PERFORATED WITHOUT RIM LOCK	182
IMPRESSION TRAYS SOLID FULL DENTURE SET OF 06 PCS	181
IMPRESSION TRAYS SOLID FULL DENTURE SET OF 8 PCS	181
IMPRESSION TRAYS SOLID WITH RIM LOCK	182
IMPRESSION TRAYS SOLID WITH RIM LOCK SET OF 06 PCS	180
IMPRESSION TRAYS SOLID WITH RIM LOCK SET OF 08 PCS	180
IMPRESSION TRAYS SOLID WITH RIM LOCK SET OF 10 PCS	180
INSTRUMENTS BOX	184
INSTRUMENTS BOX PERFORATED	184
INSTRUMENTS BOX WITH HOOKS	184
INSTRUMENTS BOX WITH LID	184
INSTRUMENTS CASSETTE 10 HINGED	191
INSTRUMENTS CASSETTE 10 PIECES CASSETTE	191
INSTRUMENTS CASSETTE 15 SURGERY KIT	191
INSTRUMENTS CASSETTE	191
INSTRUMENTS CASSETTE 20 DETACHABLE	191
INSTRUMENTS CASSETTE 20 DETACHABLE LIDS	191
INSTRUMENTS CASSETTE 20 HINGED	191
INSTRUMENTS CASSETTE 5 DETACHABLE LIDS	191
INSTRUMENTS CASSETTE 5 INHINGED LIDS WITH BUTTON LOCK	191
INSTRUMENTS CASSETTE 5 PIECES CASSETTE	191
INSTRUMENTS CASSETTE 7 INHINGED	191
INSTRUMENTS CASSETTE 7 PIECES CASSETTE	191
INSTRUMENTS TRAY PERFORATED	183,191
INSTRUMENTS TRAY PERFORATED BASE	191
INSTRUMENTS TRAY SOLID BASE	191
INSTRUMENTS TRAYS	183
INSTRUMENTS TRAYS WITH COVER	184
INSTRUMENTS TRAYS WITH LID	183
INSTRUMENTS TRAYS WITHOUT COVER	184
INTRALIGAMENTAL ANESTHESIA SYRINGE	27
IRIS GUM SCISSORS	104
IRIS SUPER CUT SCISSORS	108
IRIS GUM SCISSORS	104,105,108
IVORY SIQVELAND RETAINERS	111
IVORY LIGHT WEIGHT RUBBER DAM CLAMPS FORCEPS	111
IVORY MATRIX RETAINERS	115
IVORY RETRACTORS	111
IVORY RUBBER DAM CLAMPS FORCEPS	111
IWANSON SPRING CALIPER FOR METAL AND PORCELAIN	126
IWANSON SPRING CALIPER FOR WAX	126

J	
JACUETTE SCALER	63
JARABAK PILERS	143
JECT ULTIMA DENTAL SYRINGES	27
JENNINGS RETRACTORS - MOUTH GAGS	100
JOHNSON CONTOURING PLIERS	133
JOHNSON PLIERS FOR CROWN BAND CONTOURING	138
JONES TOWEL CLAMPS	110
JOSEPH GUM SCISSORS	105

K	
KALT NEEDLE HOLDERS TC	109
KELLS EXTRACTING FORCEPS (AMERICAN PATTERN)	15

DESCRIPTION	PAGE#
KELLY GUM SCISSORS	104,105
KELLY HAEMOSTATIC FORCEPS	110
KELLY-RANKIN HAEMOSTATIC FORCEPS	110
KEY RINGS	94
KEYS FOR IMPLANT SCREW	177
KILNER (RAGNELL) GUM SCISSORS	105
KIRKL AND SCALER	64
KLEIN EXTRACTING FORCEPS	06
KLEINERT-KUTZ BONE ROUNDING	25
KOPP ROOTS ELEVATOR	39
KRAMER NEVINS SINUS LIFT	162
KRAMER-NEVINS PERIODONTAL INSTRUMENTS	121
KRAMER-NEVINS BONE CHISEL	119
KUEHNE TWEEZERS	170
L	
LA GRANGE NEEDLE HOLDERS	109
LA GRANGE GUM SCISSORS	104,105
LADMORE FILLING INSTRUMENTS	88
LADMORE IMPLANTOLOGY	149
LAGRANGE SCISSORS	108
LAGRANGE SUPER CUT SCISSORS	108
LANGENBECK RETRACTORS	103
LANGER SCALER	63
LAP & LKEY JOINT PLIERS	139
LARGE FLUCH-CUT DISTAL AND CUTTING PLIERS	133
LAXUTOR ROOT ELEVATORS	30,31
LAXUTOR ROOT ELEVATORS SET OF 9 PCS	38
LE CRON CEMENT SPATULAS	95
LECLUSE BAYONET ROOT ELEVATOR	41
LESSMANN WAX KNIVES	96
LICHTENBERG-RYDER TC NEEDLE HOLDERS	109
LIGATURE FORMING PLIERS	134
LIGATURE INSTRUMENT SILICON GRIP	129
LIGHT WORE BIRD BEAK PLIERS WITH GROOVE	143
LINDO LEVIAN ROOT ELEVATORS	35
LINGUAL / PALATAL ARCH FORMING PLIERS	134
LINGUAL ARCH FORMING PLIERS	143
LINGUAL DENTAL PHOTOGRAPHIC MIRRORS	98
LINGUAL/PALATAL SURFACES SCALER	61
LINGUAL-LARGE DENTAL PHOTOGRAPHIC MIRRORS	98
LIP & CHEEK RETRACTOR	100
L-KEY JOINT PLIERS	135to136
LOCKLIN GUM SCISSORS	105
LONDON COLLEGE TWEEZERS	52
LONDON HOSPITAL	34
LONG IMPLANT DRILLS	176
LOOP FORMING IN FOUR LENGTH	138
LORNAHAEMOSTATIC FORCEPS	110
LUCAS IMPLANTOLOGY	168
LUER BONE ROUNDING	25
LUKS	58
LUXATING ELEVATOR / PERIOTOME	36
LUXATING ELEVATOR WITH PERIOTOME TIP	36
LUXATOR ROOT ELEVATORS	29
LUXATOR/ELEVATOR 8 PCS	191
LUXATORS SET OF 7 PCS	46
LUXATORS SET OF 7 PCS	46
LUXATORS SET OF 8 PCS	46
LUXIER ROOTS ELEVATOR	40
LUXIVATORS CURVED ATRAUMATIC LUXATION OF THE TOOTH	48
LUXIVATORS STRAIGHT ATRAUMATIC LUXATION OF THE TOOTH	48
M	
MAGNIFYING MOUTH MIRRORS	49
MALLET IMPLANTOLOGY	174
MALLETS - PLASTER SHEARS - SAWS & BLADES	124
MANUAL ASPIRATING SYRINGE	27
MANUAL CROWN REMOVERS	114
MARGIN TRIMMERS	66
MARGINAL RIDGE & EMBRASURE SHAPING INSTRUMENT	148
MARKLEY FILLING INSTRUMENTS	93
MARQUETTE CONDENSER	87
MARQUETTE PLUGGERS	87
MARYAM TWEEZERS	53
MATHIEU NEEDLE HOLDERS	107
MATRIX RETAINERS	115
MAXI HOLLOWARE INSTRUMENTS	187
MAYO GUM SCISSORS	104
MAYO NEEDLE HOLDERS	106
MAYO TRAY PERFORATED	183
MAYO-HEGAR NEEDLE HOLDERS	106,107
MCCALL SCALER	63
MEAD BONE ROUNDING	25
MEAD NON AUTO CLAVABLE PLASTIC TIPS	119
MEASURING LOOP	126
MEASURING LOOP CASTROVIEJO	126
MEASURING PROBE	145
MEISSNER EXTRACTING FORCEPS	26
MEMBRANE IMPLANTOLOGY	161
MEMBRANE 3POSITIONING IMPLANTOLOGY	150
MEMBRANE DETACH ELEVATOR	164
MEMBRANE ELEVATOR	164
MEMBRANE TWEEZERS	170
MERRIAM TWEEZERS	52
MERRIT 8 EXPLORERS	55
MERSON BAND PUSHER	129
MESH CASSETTES 5 PIECES, 7 PIECES, 10 PIECES, 15PIECES & 20 PIECES	190
MESH TRAY	190
MESH TRAYS 05 PCS	190
MESH TRAYS 07 PCS	190
MESH TRAYS 10 PCS	190
MESH TRAYS	190
MESH TRAYS 20 PCS	190
MESIAL SCALER	61
METZENBAUM GUM SCISSORS	104,106
MICOR ADSON 1X2 TISSUE FORCEPS	169
MICRO BOLEY GAUGE STRAIGHT	146
MICRO BOLEY GAUGE TWISTED	146
MICRO IRIS GUM SCISSORS	104
MICRO SURGICAL SCALPEL HANDLE TITANIUM	123
MICRO-FRIEDMAN BONE ROUNDING	25
MICRO-MINI PIN & LIGATURE CUTTER	142
MIDDELBORPF RETRACTORS	103
MILLER BONE FILES	119
MILLER ROOT ELEVATORS	37

DESCRIPTION	PAGE#
MILLER IMPLANTOLOGY	168
MILLER ROOT PLANNING FILES	119
MILLER TWEEZERS	53
MINI DISTAL AMALGAM CARRIERS	117
MINI GAUGE	127
MINI LIGATURE CUTTERS	133
MINI PIN & LIGATURE CUTTER	142
MINI PIN & LIGATURE CUTTER TC	139
MINI-LANGENBECK RETRACTORS	102
MINI-SPATEL BURNISHERS	71
MINNESOTA RETRACTORS	101
MIRROR EXPLORERS	51
MIRROR HANDLE STEM WITH RULE HANDLES FOR MOUTH MIRRORS	50
MISCELLANEOUS PRODUCTS	94
MIXING SPATULA WITH SHOVEL	165
MOLT 9 PERIODONTAL INSTRUMENTS	121
MOLT AUTO CLAVABLE PLASTIC TIPS	119
MONARI COMPOSITE MODELLING INSTRUMENTS	85
MORTENSON FILLING INSTRUMENTS	80,87
MOUTH MIRROR EXPLORERS	51
MOUTH MIRRORS	49
MOUTH PROPS	94
MOVEABLE HEIGHT GAUGE	125
MSY CEMENT SPATULAS	95
MUEBEMANN SCALER	64,85
MULTIFUNCTIONAL METER	145
MULTI-PURPOSE PLIERS	137
N	
NAKAWANI DENTAL LABORATORY INSTRUMENT	97
NANCE LOOP FORMING PLIERS	132,137
NAPKIN HOLDER WITH METAL CHAIN	94
NAPKIN HOLDER WITH PLASTIC CHAIN	94
NARROW SIQVELAND RETAINERS	115
NEEDLE HOLDERS	106to109
NEEDLE STERILIZATION TUB	186
NEUMANN GUM SCISSORS	105
NEVIUS EXTRACTING FORCEPS (AMERICAN PATTERN)	14,16
NORMAL HANDLE EXPLORERS	54
NOYES GUM SCISSORS	105
O	
OBTUSE IMPLANTOLOGY	161
OCLUSAL ANATOMY INSTRUMENT	146
OHL PERIOSTEAL ELEVATORS	120
OLSEN-HEGAR NEEDLE HOLDER WITH SCISSORS	107
OMEGA LOOP FORMING PLIERS	141
ORBAN SCALER	64
ORTHO BAND PUSHER SCALER	131
ORTHO INSTRUMENT	130
ORTHO LIGATURE DIRECTOR SINGLE ENDED	131
ORTHO LIGHT BAND PUSHER SCALER	129
ORTHO LIGHT DOUBLE ENDED LIGATURE	131
ORTHO LIGHT DOUBLE ENDED LIGATURE DIRECTOR	131
ORTHO LIGHT DOUBLE ENDED LIGATURE DIRECTOR SCALER	129,131
ORTHO LIGHT DOUBLE ENDED LIGATURE SCALER	131
ORTHO LIGHT LIGATURE DIRECTOR DOUBLE ENDED	131
ORTHO LIGHT SCALER	130
ORTHO LIGHT SCALER DOUBLE ENDED	130
ORTHO LIGHT SCALER HEAVY	130
ORTHO LIGHT SCALER SINGLE ENDED	131
ORTHO RULER / CONE SOCKET	146
ORTHODONTIC INSTRUMENTS	129to131
ORTHODONTICS PLIERS STANDS	144
ORTHOLITE LIGATURE DIRECTOR SCALER	131
OSTEOMETER MEASURING FORCEPS FOR JAW	146
OSTEOTOME CONVEXES / CONCAVE / CONIQUES	171,172
OSTEOTOME CONVEXES / CONCAVE / CONIQUES SET OF 5 PIECES	172
P	
P.K. THOMS WAXING INSTRUMENTS KIT	89
P.K. THOMS WAXING INSTRUMENTS SOLID HANDLE	89
PALATAL-ADULT DENTAL PHOTOGRAPHIC MIRRORS	98
PALATAL-ADULT LARGE DENTAL PHOTOGRAPHIC MIRRORS	98
PALATAL-CHILD DENTAL PHOTOGRAPHIC MIRRORS	98
PALMER RUBBER DAM CLAMPS FORCEPS	111
PARMLY EXTRACTING FORCEPS (AMERICAN PATTERN)	16
PARTSCH PERIOSTEAL ELEVATORS	120
PDL ELEVATORS	47,48
PDL ELEVATORS SET OF 7 PCS	47
PDL ELEVATORS SET OF 7 PCS	47
PDL ELEVATORS SET OF 8 PCS	47
PEDIATRIC TOOTH EXTRACTING FORCEPS SET	08
PEET SPLINTER FORCEPS	109
PERFORATED WITH RIM LOCK SET OF 06 PCS	179
PERFORATED WITH RIM LOCK SET OF 10 PCS	179
PERFORATED WITH RIM LOCK SET OF 8 PCS	179
PERIODONTAL CHISELS	118
PERIODONTAL INSTRUMENTS	120to122
PERIODONTAL KNIVES	64
PERIODONTAL PROBES	58
PERIODONTAL PROGRESSPREADERS	57
PERIODONTAL SURGERY	162
PERIOSTEAL ELEVATORS	120,154
PERIOTOME ROOTS ELEVATOR	43
PERRY TWEEZERS	52,53
PHYSIC EXTRACTING FORCEPS (AMERICAN PATTERN)	18
PIN & LIGATURE CUTTER	142
PIN & LIGATURE CUTTERS TC	139
PIN HOLDING PLIER TC	140
PIN-TWEEZERS	170
PLAIN MOUTH MIRRORS	49
PLANATOR	69
PLANATOR	69
PLASTER KNIFE	96
PLASTER SHEARS	124
PLASTIC FILLING INSTRUMENTS	93
PLIER STAND PLASTIC	144
PLIER STAND STAINLESS STEEL	144
PLIERS FOR ORTHODONTICS & PROSTHETICS	132to143
PLIERS STAND STAINLESS ROD (ALUMINIUM ANODIZED)	144
PLUGGERS	56
PLUGGERS/CONDENSERS	87
POSITIONING 3 IMPLANTOLOGY	161

DESCRIPTION PAGE#

POSITIVE POSTIONER	125
POSTERIOR BAND REMOVING PLIERS - LONG	141
POSTERIOR BAND REMOVING PLIERS - SHORT	141
POTTS "I-HANDLE" ELEVATOR-LEFT	41
POTTS "I-HANDLE" ELEVATOR-RIGHT	41
PRICHARD PERIODONTAL INSTRUMENTS	121
PROBE EXPLORERS	51
PRONG 3 CLASP ADJUSTABLE PLIER TC.	140
Q	
QUATRO DENTAL SYRINGES	27
R	
RASPATOR, PRICHARD	165
RASPATOR, RASPATORY	120
RASPATOR, WILLIGER	120
RECTANGULAR ARCH BENDING PLIERS	143
RETRACTOR SELDIN	103
RETRACTORS - MOUTH GAGS	99,100
RETRACTORS	101to103
RHODIUM MOUTH MIRRORS	49
RIBBON RETRACTORS	101
RIDGE MAPPING DOUBLE CALIPER	146
RING 2 DENTAL SYRINGES	27
ROCHESTER-KOCHER HAEMOSTATIC FORCEPS	110
ROCHESTER-PEAN HAEMOSTATIC FORCEPS	110
ROOT CANAL FLUGGER	56
ROOT ELEVATOR	29to48
ROOT ELEVATORS SET OF 10 PCS	46
ROOT FRAGMENT FORCEPS	09,11
ROOT PICK ELEVATOR WITH GOLD FLEXIBLE POINTS	42
ROOT PLANNING FILES	119
ROOT PLANNING FILES & BONE FILES	119
ROOTS SPLINTER FORCEPS	10
ROSER-KÖNIG RETRACTORS - MOUTH GAGS	100
ROUND AND CONCAVE PLIER	139
ROUND ENDODONTIC BOXES	186
ROUND EXCAVATOR	86
ROUND TORQUE WRENCH UNIVERSAL	177
ROUTURIER EXTRACTING FORCEPS (ENGLISH PATTERN)	03
ROUTURIER EXTRACTING FORCEPS FOR LOWER MOLARS	03
RUBBER DAM CLAMPS	113
RUBBER DAM CLAMPS FORCEPS	111
RUBBER DAM CLAMPS KITS	112
RUBBER DAM FRAME	111
RUBBER DAM TEMPLATE	112
RULER	127
RULER WEDGE	127
RUSSIAN LONG TISSUE FORCEPS	170
RUSSIAN TISSUE FORCEPS	170
RYDER NEEDLE HOLDERS	106,107
S	
SAW BLADES	124
SCALER	59to67
SCALERS TRAYS	163
SCALPEL HANDLE STRAIGHT	123
SCALPEL HANDLES	123
SCHLEMMER ROOTS ELEVATOR	37
SCHMIDLIN PERIODONTAL INSTRUMENTS	122
SCHURE BAND SEATER	130
SCHWARZ PLIERS	139
SEPARATING ELASTIC PLIER	111
SELDIN PERIODONTAL INSTRUMENTS	122
SELDIN ROOT ELEVATORS	29,32
SELF LOCKING GROOVED	169
SELF-LOCKING TWEEZER	53
SEMKEN TAYLOR TWEEZERS	52
SENN MUELLER RETRACTOR	102
SERRATED PLUGGERS	84
SET OF 5 PIECES	171
SHEPHERD'S HOOK EXPLORER	54
SHORT IMPLANT DRILLS	176
SICKLE SCALERS	63
SIMPLEX RETRACTOR	100
SINUS ELEVATOR & MEMBRANE LIFT TIPS	164
SINUS IMPLANTOLOGY	156,161
SINUS LEFT ELEVATOR & MEMBRANE LIFT TIPS 3 SET OF 7 PCS	164
SINUS LEFT ELEVATOR SET OF 10 PCS	158
SINUS LIFT ELEVATOR	151,157
SINUS LIFT ELEVATORS SET OF 7 PCS WITH CASSETTE	157
SINUS LIFT INSTRUMENT	150to152,161
SINUSLIFT IMPLANTOLOGY	150,161
SIOVELAND RETAINERS	115
SLIM WEINGART PLIERS	141
SLIPPER TWEEZERS	128
SMAHA ELASTOMERIC LIGATURE PLACING FORCEPS	140
SMALL/MEDIUM BALL BURNISHER	149
SOFT BRUSHING KIT SET OF 6 PCS	163
SOFT WIRE AND LIGATURE CUTTER	135
SOFT WIRE AND LIGATURE CUTTER, STANDARD	135
SPATULAS	73
SPATULAS ROUNDED AND SHARP	72
SPECIAL INOX	124
SPECIAL INOX WAX KNIVES	96
SPENCER GUM SCISSORS	105
SPIRIT LAMP	186
SPLINTER FORCEPS	10
SPOON AND PUSHER (TRINOVO)	167
STANDARD LIGATURE CUTTER TC.	139
STAR TORQUE WRENCH UNIVERSAL	177
STERILIZING BOXES & INSTRUMENTS TRAYS	184
STERILIZING MESH TRAY	190
STERNBERG RETRACTORS	99
STIEGLITZ ROOT FRAGMENTS	10
STIEGLITZ SPLINTER FORCEPS	10
STOCKES RUBBER DAM CLAMPS FORCEPS	111
STOP PLIERS V-BEED	137
STRAIGHT DIRECT BOND BRACKET REMOVER TC.	140
STRIP SAW	125
SUCTION CANNULA KIT WITH 3 NEEDLES	178
SUCTION NEEDLE	178
SUCTION PIPE	178
SUCTION TUBES	178
SURGICAL TWEEZERS	52

DESCRIPTION PAGE#

SURGICAL BALL HOOK CRIMPING PLIERS, ANGLED	137
SURGICAL BALL HOOK CRIMPING PLIERS, STRAIGHT	137
SURGICAL CHISELS	162
SUTURE PLIERS SUTURE FORCEPS	169
SWEDISH TYPE DENTAL SYRINGES	27
SYNDESMOTOMES ROOTS ELEVATOR	43
T	
TAMPER	166
TANNER FILLING INSTRUMENTS	88
TARTAR REMOVER INSTRUMENTS SOLID HANDLE	67
TAYLOR SCALER	63
THICK EXPLORERS	54
THREE JAW PLIERS	143
TISSUE GRAFT FORCEP SERRATED TEETH	169
TISSUE MEMBRANE FORCEPS	169,170
TISSUE PUNCH	173
TISSUE PUNCH FORCEPS TO REMOVE TISSUE AFTER USING PUNCH	170
TISSUE PUNCH SET OF FIVE PIECES	173
TISSUE PUNCH STRAIGHT & CURVED	173
TISSUE PUNCH WITH PIN SET OF FOUR PIECES	173
TITANIUM LOCKING PLIER	169
TITANIUM PERIOSTEAL ELEVATOR FOR IMPLAN	122
TOFFLEMIRE-JUNIER SIOVELAND RETAINERS	115
TOFFLEMIRE-SENIOR SIOVELAND RETAINERS	115
TOMAS EXTRACTING FORCEPS (AMERICAN PATTERN)	17,22
TÖNNIS NEEDLE HOLDERS	109
TORQUE WRENCH & RATCHET	177
TORQUING PLIERS SET	137
TOWNER-JAQUETTE SCALER	63
TREPINE	175
TREPINE DRILL SET OF EIGHT PIECES	175
TRINOVO HANDLE	167
TRIO DENTAL SYRINGES	27
TRIPLE-ANGLED BACK ACTION EXCAVATOR	86
TWEED / ANGEL FORMING AND TORQUING PLIERS	134
TWEED / ANGEL RECTANGULAR ARCH FORMING AND TORQUING PLIERS	137
TWEED / ANGLE RECTANGULAR ARCH FORMING & TORQUING PLIERS	133
TWEED LOOP FORMING PLIERS	132,133,143
TWEEZERS	52,53
TWEEZERS EXPLORERS	51
TWEL-ON ELASTIC MODULE INSTRUMENT	130
TYPE C DENTAL SYRINGES	27
U	
UNIQUE RETRACTORS	102
UNIVERSAL CROWN REMOVER	114
UNIVERSAL CURETTES	63
UNIVERSAL CUT & HOLD DISTAL END CUTTER	142
UNIVERSAL DOLPHIN STYLE WIRE BENDING & CUTTING PLIERS	132
UNIVERSAL EXTRACTING FORCEPS (AMERICAN PATTERN)	22
UNIVERSAL MINI-ELEVATOR FOR FRAGMENTS	34
UNIVERSAL NEEDLE HOLDERS	106
UNIVERSITY OF MICHIGAN EXPLORERS	55
UNIVERSITY OF NORTH CAROLINA EXPLORER	55
UPPER ROOT ELEVATOR WITH HELICOIDAL TIP	31
US ARMY RETRACTORS	102
UTILITY PLIER WEINGART TC.	140
V	
V BEND STOP	139
V BEND STOP PLIER TC.	139
VERNIER GAUGE	127
VISTA TUNNELING INSTRUMENTS SET	155
W	
W. BARRY ROOTS ELEVATOR	41
WAHL BONE FILES	119
WAKAI HEAT CARRIERS	57
WALDSAVHS WIRE BENDING AND CUTTING PLIERS	134
WANGEN HOLDER	99
WARD FILLING INSTRUMENTS	80
WATER SYRINGE	116
WAX KNIVES	96
WAY 6 ADJUSTABLE ANGLED SCALPEL HANDLE	123
WEIDER RETRACTOR	99
WEINGART PLIER	139
WEINGART PLIER MEDIUM	132,134
WEINGART PLIERS	141
WEINGART UTILITY PLIERS	136
WEINGART-MINI UTILITY PLIERS	136
WEITLANER RETRACTORS - MOUTH GAGS	100
WERDELSTÄDT SCALER	67
WESTCOTT BURNISHERS	68
WESTCOTT FILLING INSTRUMENTS	93
WESTON CEMENT SPATULAS	95
WHITE BURNISHERS	68
WIDE SIOVELAND RETAINERS	115
WILAND SCALER	65
WILKINS/TUFTS EXPLORER	54
WILLIAMS EXPLORERS	55
WILLIAMS FILLING INSTRUMENTS	81
WINTER EXTRACTING FORCEPS (AMERICAN PATTERN)	12
WINTER ROOTS ELEVATOR	41
WIRE BENDING & LOOP FORMING PLIERS	132
WIRE BENDING AND LOOP FORMING PLIERS ANGLED (BIRD BEAK)	136
WISDOM EXTRACTING FORCEPS	03
WISDOM ROOT ELEVATOR	36
WITZEL FORCEPS WITH ANATOMICAL HANDLE SET OF 3 PCS	09
WITZEL FORCEPS WITH GOLD SET OF 3 PCS	09
WITZEL FORCEPS WITH HOLE AND SCREW PATTERN SET OF 3 PCS	09
WITZEL ROOT FRAGMENT FORCEPS	09
WOODEN HANDLE WAX KNIVES	96
X	
X RAY FILM HANGERS	94
Y	
YOUNG TONGUE FORCEPS	110
YOUNG WIRE BENDING & LOOP FORMING PLIERS	132
YOUNGER GOOD SCALER	63
Z	
ZAHLE CEMENT SPATULAS	95

NEW EDITION

DENTAL

INSTRUMENTS

Extraction Sets
Extracting Forceps
Root Elevators
Bone Rongeurs
Orthodontic Pliers
Scalers
Impression Trays



ELITE INTERNATIONAL